



INVEST IN THE FUTURE

# COLLISION REPAIR



SPOT WELDING - DENT PULLING - MIG-MAG/GMAW-FCAW - PLASMA CUTTING  
INDUCTION - RIVETING - LIFTING - BODYSHOP TOOLS

2025 A

## A solid manufacturing group



900 people

C1+

Credit Rating  
Banque de France



€ 140 000 000



55 000 m<sup>2</sup>  
2 factories



FRENCH MANUFACTURER  
SINCE 1964

## A family company



Nicolas & Bruno  
Bouygues



## Global coverage

125 countries

## 3 catalogues

3 500+ references



MMA/SAW  
TIG/GTAW  
MIG-MAG/GMAW-FCAW  
Plasma cutting  
Induction heating  
Stud welding  
Spot welding  
Accessories  
Protection  
Consumables



Spot welding  
Dent pulling  
MIG-MAG/GMAW-FCAW  
Plasma cutting  
Induction heating  
Riveting  
Lifting  
Bodyshop tools

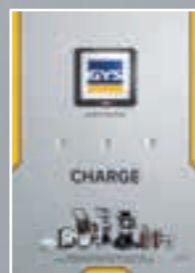

Chargers  
Battery support units  
Boosters  
Starters  
Testers  
Portable energy  
Jumper cables  
EV charging  
Accessories



**GYS FRANCE - HEADQUARTERS**  
Laval



**GYS LOGISTIC CENTER**  
Laval



**GYS GERMANY**  
Aachen



**GYS U.K.**  
Rugby



**GYS CHINA**  
Shanghai



**GYS ITALIA**  
Venezia



**GYS IBERICA**  
Madrid

## Table of contents

<b>DENT PULLING</b> .....	5 > 37
<b>PULLING SYSTEMS</b> .....	38 > 45
<b>PAINTLESS DENT REPAIR</b> .....	46 > 51
<b>SPOT WELDING</b> .....	52 > 69
<b>RIVETING</b> .....	70 > 81

<b>MIG WELDING</b> .....	82 > 95
<b>PLASMA CUTTING</b> .....	96 > 100
<b>INDUCTION HEATING</b> .....	101 > 109
<b>TRUCK TOOLS &amp; MOBILE LIFTS</b> .....	110 > 116
<b>ACCESSORIES</b> .....	117 > 143



MANUFACTURER  
SINCE 1964

★★★★★ **THEY TRUST US** ★★★★★

ILS NOUS FONT CONFIANCE

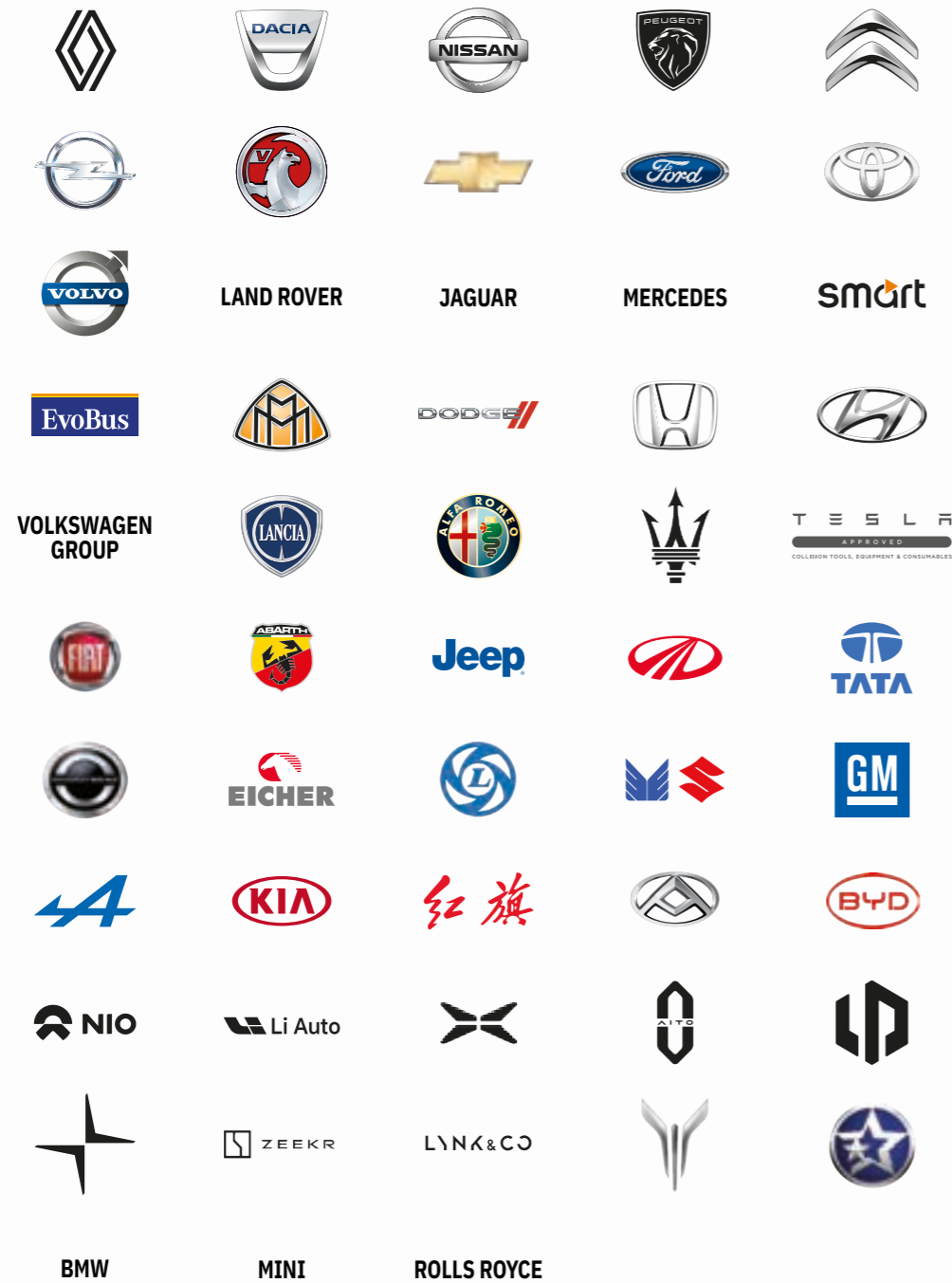

# DENT PULLING

ALU + STEEL / ACIER / STAHL

GYSLOT COMBI	9
ACCESSORIES & CONSUMABLES	10

DRAWN ARC  
ALU + STEEL / ACIER / STAHL

GYSLOT ARCPULL	12
COMBI ARCPULL	13
ACCESSORIES & CONSUMABLES	16

STEEL / ACIER / STAHL

GYSLOT	6
GYSLOT PRO	7

ALU

GYSLOT ALU	8
------------	---

FAST DENT PULLING	18
LEVELLING BARS	20

COMPLETE WORKSTATIONS	24
-----------------------	----





GYSPOT

# DENT PULLING STEEL ACIER - STAHL

- Stars - Étoiles - Ausbeulstern
- Rings - Anneaux - Zugösen
- Wavy wires - Fils ondulés - Wellendraht
- Impact shrinking - Rabattage d'impact - Glätten

## OPTIONS

Consommables - Consumables p.10



Chariots - Trolleys p.24



- Stars - Étoiles - Ausbeulstern
- Rings - Anneaux - Zugösen
- Wavy wires - Fils ondulés - Wellendraht
- Impact shrinking - Rabattage d'impact - Glätten
- Tempering - Rétreinte - Temperieren



**FIXED GUN**

**FIXED GUN**

GYSPOT 26.02

**2600 A** x1 **AUTOMATIC**

230V • 1~

052208

included

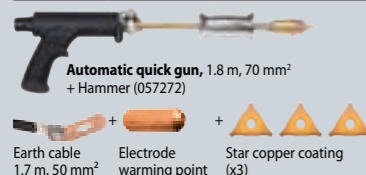

Earth cable 1.7 m, 50 mm<sup>2</sup> Electrode warming point Star copper coating (x3)

GYSPOT 27.02

**2600 A** x1 **MANUAL**

230V • 1~

055353

included

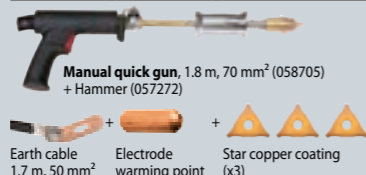

Earth cable 1.7 m, 50 mm<sup>2</sup> Electrode warming point Star copper coating (x3)

GYSPOT 34.02 & 34.04

**3500 A** x1 **MANUAL**

230V • 1~

GYSPOT 34.02  
065741

400V • 2~

GYSPOT 34.04  
067943

included

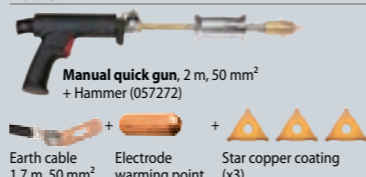

Earth cable 1.7 m, 50 mm<sup>2</sup> Electrode warming point Star copper coating (x3)

- Stars - Étoiles - Ausbeulstern
- Rings - Anneaux - Zugösen
- Wavy wires - Fils ondulés - Wellendraht
- Impact shrinking - Rabattage d'impact - Glätten
- Tempering - Rétreinte - Temperieren
- Rivets - Rivets - Nieten
- Rings - Rondelles - Unterlegscheiben
- Studs - Goujons - Gewindebolzen

SYNERGIC CONTROL

PATENTS REGISTERED NUMBERS EUROPEAN TRADEMARK & DESIGN



**GUN WITH CONNECTOR**

GYSPOT 39.02 & 39.04

**3800 A** x1 **AUTOMATIC**

230V • 1~

GYSPOT 39.02  
052215

400V • 2~

GYSPOT 39.04  
052222

included

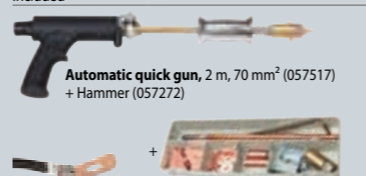

Earth cable 2 m, 70 mm<sup>2</sup> SPOTTER BOX STANDARD (053915) (Details p.10)

GYSPOT PRO 230 & PRO 400

**3800 A** x2 **AUTOMATIC**

230V • 1~

GYSPOT PRO 230  
052178

400V • 2~

GYSPOT PRO 400  
052185

included

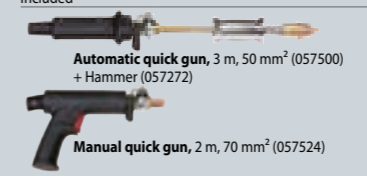

Earth cable 2 m, 70 mm<sup>2</sup> SPOTTER BOX PRO (050075) (Details p.10)

GYSPOT EXPERT 200, 230 & 400

**3800-4500 A** x2 **AUTOMATIC**

230V • 1~

GYSPOT EXPERT 230  
066885

200-240V • 1~

GYSPOT EXPERT 200  
058842

4350 > 5100 A

400V • 2~

GYSPOT EXPERT 400  
058859

included

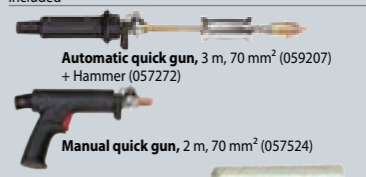

Earth cable Thick 3 mm 2 m, 70 mm<sup>2</sup> SPOTTER BOX PRO (050075) (Details p.10)

QUICK GUNS

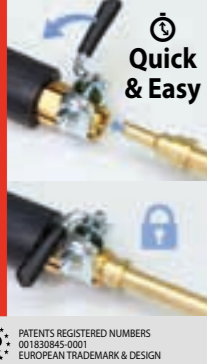

Quick & Easy

**AUTOMATIC**



**WITH CONNECTOR**  
2 m, Ø 70 mm<sup>2</sup>  
included 39.02/04  
057517



**WITH CONNECTOR**  
3 m, Ø 50 mm<sup>2</sup>  
included PRO 230/400  
057500

**WITH CONNECTOR**  
3 m, Ø 70 mm<sup>2</sup>  
included EXPERT 200/230/400  
059207

**MANUAL**



**WITH CONNECTOR**  
cable 2 m, Ø 70 mm<sup>2</sup>  
included PRO 230/400,  
EXPERT 200/230/400,  
COMBI 230EPRO  
057524

No connector  
cable 1.8 m, Ø 70 mm<sup>2</sup>  
for 27.02  
058705

No connector  
cable 2 m, Ø 50 mm<sup>2</sup>  
for 34.02/34.04

Mandrels for gun -  
Mandrins pour pistolets  
- Pistole & Anschlußstücke,  
Zubehör



QUICK GUN  
057531



D1  
048959

Nut - Écrou  
053199

Microswitch  
053267

	GYS CHINA	GYS FRANCE	I <sub>2</sub> max	U <sub>2</sub>	I <sub>AM</sub>	I <sub>RMS</sub>	kW	SYNERGIC	AUTOMATIC	MANUAL	SEPARATE CABLE GUN	LxWxH cm / kg
MADE IN GYS CHINA	GYSPOT 26.02	230V	2600	5,4	16	1800	10	OK	—	—	—	40 x 25 x 31 / 18
	GYSPOT 27.02	230V	2600	5,4	16	1800	10	OK	—	—	—	40 x 25 x 31 / 18
	GYSPOT 34.02	230V	3500	7,4	16	2500	20	OK	OK	—	—	42 x 36 x 31 / 23.9
	GYSPOT 34.04	400V, 2ph	3500	7,4	16	2500	20	OK	OK	—	—	42 x 36 x 31 / 24
	GYSPOT 39.02	230V	3800	7,4	16	2800	20	OK	OK	—	—	49 x 38 x 29 / 27.5
	GYSPOT 39.04	400V, 2ph	3800	7,4	16	2800	20	OK	OK	—	—	49 x 38 x 29 / 25.2
	GYSPOT PRO 230	230V	3800	7,4	16	2800	20	OK	OK	—	—	49 x 38 x 29 / 29.6
	GYSPOT PRO 400	400V, 2ph	3800	7,4	16	2800	20	OK	OK	—	—	49 x 38 x 29 / 29.4
	GYSPOT EXPERT 200	200-240V	4350 > 5100	7,2-8,7	30(D)	3100 > 3600	25 > 36	OK	OK	—	—	49 x 38 x 29 / 34.6
	GYSPOT EXPERT 230	230V	3800	7,4	16	2800	20	OK	OK	—	—	49 x 37 x 31 / 30.6
	GYSPOT EXPERT 400	400V, 2ph	4500	7,4	16(D)	3200	25	OK	OK	—	—	49 x 38 x 29 / 32.9



GYSPOT ALU

# DENT PULLING ALU



SYNERGIC CONTROL

PATENTS REGISTERED NUMBERS  
EUROPEAN TRADEMARK & DESIGN



Goujons - Studs



**FIXED GUN**

GYSPOT ALU 66

**13000 A** x1 **AUTOMATIC**

230V • 1~ **AD**

080188

included for Ø 4 mm



**AD** ANTI-DUST

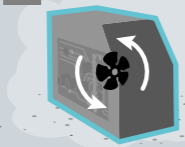

GYSPOT ALU PRO FV

**13000 A** x1 **AUTOMATIC**

110 > 230V • 1~ **FV**

021990

included for Ø 4 mm



**FV** FLEXIBLE VOLTAGE

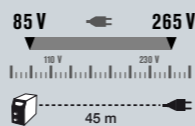

**ALU GUN**

**AUTOMATIC**

3 m, Ø 25 mm<sup>2</sup>

included SPOT ALU FV & COMBISPOT 230

054066



(x 3)  
065635

**66 mF** CAPACITOR DISCHARGE WELDING

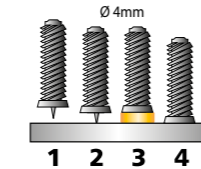

Joint rings for mandrel Ø 4/5/6 x 2  
060814

**OPTIONS**

Consumables - Consommables p.11



ALU accessories - Accessoires ALU p.19



Trolleys - Chariots p.24



GYSPOT COMBI

# DENT PULLING ALU+STEEL ACIER - STAHL

PATENTS REGISTERED NUMBERS  
EUROPEAN TRADEMARK & DESIGN

Steel / Acier / Stahl

Alu



- Stars - Étoiles
- Rings - Anneaux
- Wavy wires - Fils ondulés
- Impact shrinking - Rabattage d'impact
- Tempering - Rétreinte
- Rivets - Rivets
- Rings - Rondelles
- Studs - Goujons

**2 GUNS INCLUDED**



**GUN WITH CONNECTOR**

GYSPOT COMBI 230 E.PRO

**3800 A** Acier / Steel / Stahl

**13000 A** Alu

230V • 1~



**AUTOMATIC**

**MANUAL**

**AUTOMATIC**

021266

included

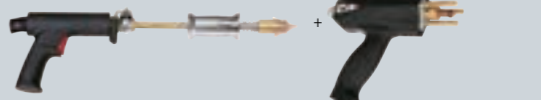

Manual quick gun, 2 m, 70 mm<sup>2</sup> (057524) + Hammer (057272)

Automatic alu gun, 3 m, 25 mm<sup>2</sup>

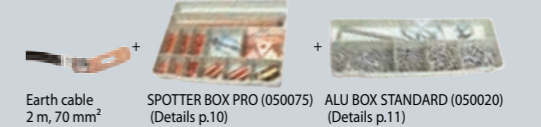

Earth cable 2 m, 70 mm<sup>2</sup>

SPOTTER BOX PRO (050075) (Details p.10)

ALU BOX STANDARD (050020) (Details p.11)

				$I_2$ max	$U_2$	$I_{RMS}$	kW				SYNERGIC				MANUAL	SEPARATE CABLE GUN		LxWxH cm / kg
MADE IN GYS CHINA	62135	50/60 Hz		A	V	A	A	OK	OK	MANUAL	■	■	■	■	x1	—	3 m	Included Alu box 27 x 20.5 x 27 / 13.5
MADE IN FRANCE	GYSPOT ALU PRO FV	110 > 230V	6 m	13 000	50 > 200	5	—	0.65	OK	OK	■	■	■	■	x1	—	3 m	Included Alu box 49 x 38 x 29 / 13.4
	GYSPOT COMBI 230 E.PRO	230V	8 m	3800 (steel) 13000 (alu)	7,4 (steel) 50 > 200 (alu)	16	2800 (steel)	20	OK	OK	—	■	■	■	x1	x1	2/3 m	Included Spotter box + Alu box 54 x 76 x 34 / 47.5

GYSPOT

ALU + STEEL DENT PULLING



## STEEL / ACIER / STAHL

**DENT BOX**  
CONSUMABLES / BAR / EASY

**SPOTTER BOX**  
STANDARD / 2600 / 2700

**SPOTTER BOX**  
PRO

Star - Étoile - Ausbeulstern	Ring - Rondelle - Unterlegscheiben	Tempering - Rétreinte - Temperieren	Impact shrinking & Lock nut - Rabattage d'impact & Écrou - Glätten	Wavy wire - Fil ondulé - Wellendraht
hexagon Earth plate small	chuck for inertia hammer copper coating star	electrode ø 8 x 16 earth hook	carbon heating electrode	electrode warming point ø 16 Ball electrode warming point ø 16 M8 for spot welding machine only
x1 x20	x1 x100 x1	x5	x1 x1 x100	x1 x50 x1
049482 052239	049574 049444 056718	049468	049567 059726 050303	049789 049727 049772

Rings - Anneaux - Zugösen	Studs - Goujons - Gewindebolzen	Rivets - Rivets - Nieten	Nails - Clous	Stitch welding - Molette	Rubber pad 062399
elec-trode straight rings twisted rings lifting rod	elec-trode for threaded studs rivets ø 5 - M5, M6 threaded M5 x 18 x 0.8 self-threading ø 5 x 18 ø 5 x 12	elec-trode ø 16, 3 x 4,50 ø 3 x 3,25 ø 3 x 4,50	elec-trode ø 2 - M4 ø 2	elec-trode wheel ø 16 flat n°27 Earth plate large magnetic Steel gun earth adapter ø 25 mm²	
x1 x100 x50 x3 180, 300, 500 mm	x1 x100 x100 x100	x1 x100 x100	x1 x100	x1 x1 x1 x1	
050655 050648 050631 050792	049598 049383 049420 049413	049604 049345 049352	049277 041561	050310 049673 052529 049666 051997	

### DENT BOX

<b>CONSUMABLES</b> 051515	x20
<b>BAR</b> 050037 Ideal PROLINER	x1 x25
<b>EASY</b> 053632 Included EASYLINER	x1 x25

### SPOTTER BOX

<b>PRO</b> 050075 Included PRO, EXPERT & COMBI 230	x1 x1 x1 x20 x1 x50 x1 x1 x1
<b>STANDARD</b> 053915	x1 x1 x1 x20 x1 x50 x1 x1 x1
<b>2600</b> 052277 Ideal GYSPT 2600	x20 x1 x50 x1
<b>2700</b> 053922 Ideal GYSPT 2700	x20 x1 x50 x1 x1

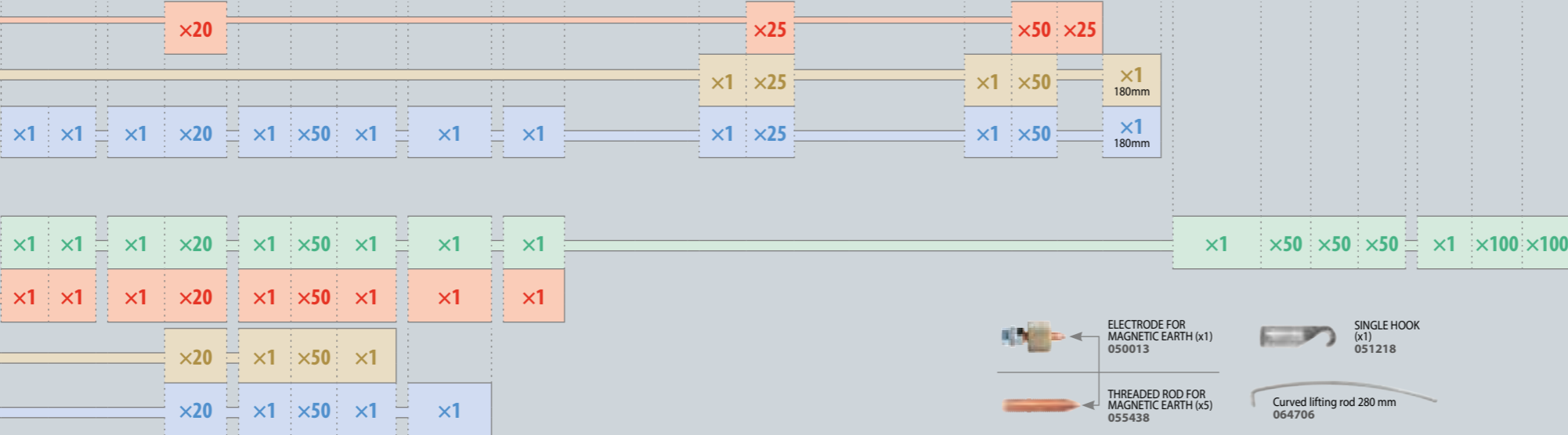

- ELECTRODE FOR MAGNETIC EARTH (x1) 050013
- THREADED ROD FOR MAGNETIC EARTH (x5) 055438
- SINGLE HOOK (x1) 051218
- Curved lifting rod 280 mm 064706



## SLIDE HAMMERS - Marteaux inertie - Ausbeulhammer

**1.1 kg**  
049802

M14

Options: (x1) 054028, (x5) 050839

**COMPLETE**  
057272

included (x1) 049482 + included (x20) 052239

Washers - Rondelles - Ringe  
051201

**1.7 kg**

51 cm

M14

for: ø 16, 8x16 (x1) 049574, 8x16 (x100) 049444, (x1) 051218

**6 kg**  
Slide hammer kit + 5 hooks  
- Kit marteau à inertie + 5 crochets  
- Ausbeulhammerset + 5 Haken  
051928

67 cm

Nails - Clous - Nägel  
041813

**1.1 kg**

for: ø 2, M4 (x1) 049277, ø 2 (x100) 041561, MIG/MAG nozzle for Nail welding 041523

**COMPLETE KIT**  
051225

**2.5 kg**  
049819

M14

(x1) (x50), (x1) (x1), (x25) (x1)

**5 kg** NEW 03/2025  
087828  
+ 6 hooks

**9 kg** NEW  
085930  
+ 6 hooks

73 cm

Pulling handle 3 claws  
- Poignée de tirage 3 dents  
- Handzugkralle 3-fach  
057326

**NEW**

M10/M14

3 teeth PREMIUM 059658

Pulling handle with hook  
- Poignée de tirage avec crochet  
057319

M10/M14

1 tooth PREMIUM 082021

## ALU

Joint rings for mandrel ø 4/5/6 x2 060814

ALU BOX LIGHT ø 4 / STANDARD ø 4 / ø 5 & 6

mandrel for ALU GUN	alu magnesium screws 12 mm	alu silicon screws 12 mm	screwable rings	fast pulling rings	lifting rod
ø 4 x2 049000	ø 4 - M4 x200 050273	ø 4 - M4 x1000 050129	ø 4 x5 050297	ø 4 x5 058712	x3: 180, 300, 500 mm 050792
ø 5 x1 048157	ø 5 x100 048140	ø 5 x100 048133	ø 5 x100 048126	ø 5 x100 048126	
ø 6 x1 048164	ø 6 x100 048133	ø 6 x100 048133	ø 6 x100 048133	ø 6 x100 048133	

### ALU BOX

<b>LIGHT ø 4</b> 051522	ø 4 x200	ø 4 x200	ø 4 x200	ø 4 x200	
<b>STANDARD ø 4</b> 050020 included GYSPT ALU & COMBI 230	ø 4 x200	ø 4 x200	ø 4 x200	ø 4 x200	x5 x1
<b>ø 5 &amp; 6</b> 048195	x1 x1	ø 5 x100 + ø 6 x100	ø 5 x100 + ø 6 x100		x5



# DENT PULLING DRAWN ARC ALU + STEEL

ACIER - STAHL



MANUAL



EXPERT Control

- Rings - Anneaux - Zugösen
- Studs - Goujons - Gewindebolzen
- Stainless steel nails - Tiges inox - Edelstahlnägel



- Start-up - Amorce - Zündung
- Scouring (I & t) - Décapage - Abbeizen
- Arc (I & t) - Arc - Lichtbogen
- Hitching (I & t) - Accroche - Verklebung
- Height - Hauteur - Höhe

7 languages  
FR, EN, DE, SP, IT, NL & RU

## SYNERGIC DIGITAL GUNS

★★★★★  
**UNIQUE Linear Motor**

**DRAWN ARC PROCESS**  
Gas protection

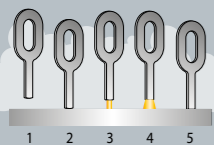

3 m, Ø 25 mm<sup>2</sup>  
included  
ARCPULL 200 & 350,  
COMBI ARCPULL



Full control



Consumables for Gun



FV FLEXIBLE VOLTAGE

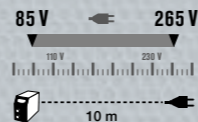

SR SECONDARY REGULATION

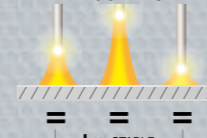

AD ANTI-DUST



MANUAL & SYNERGIC CONTROL



Ø max  
Alu : 6 mm  
Fe : 6 mm



GUN WITH CONNECTOR

### GYSPOT ARCPULL 200 COLLISION REPAIR

100 · 230V · 1~  
**200 A** x1 MANUAL  
FV SR AD  
057470  
included

- Manual synergic gun 3 m, 25 mm<sup>2</sup> (059610)
- ALU RING BOX 1.5 mm (AlSpec + AlMg3 + AlMgSi) 059429
- Lifting rod 180 mm (x1) 082915

### OPTIONS

Weld 810 for ARCPULL 200 037489

### GYSPOT COMBI ARCPULL

230V · 1~  
**ARCPULL 200 A** (Alu) x1 MANUAL  
**EXPERT 3800 A** (Acier / Steel / Stahl) x1 MANUAL

069824

Arccpull accessories included

- Manual synergic gun 3 m, 25 mm<sup>2</sup> (059610)
- ALU RING BOX 1.5 mm (AlSpec + AlMg3 + AlMgSi) 059429
- Lifting rod 180 mm (x1) 082915

Expert accessories included

- Manual quick gun, 2 m, 70 mm<sup>2</sup> (057524) + Hammer (057272)
- Earth cable, 2 m, 70 mm<sup>2</sup>
- SPOTTER BOX PRO (050075) (Details p.10)

MADE IN FRANCE 60974-1	50/60 Hz	I <sub>2</sub> A	SYNERGIC	MANUAL	IRMS (A)	GUN		U <sub>2</sub> V	A	kW	OK	OK	LxWxH cm / kg
						Acier/Steel	Alu						
<b>GYSPOT ARCPULL 200 COLLISION REPAIR</b>	110 · 230V	6 m	10 · 100 (110 V) 10 · 200 (230 V)	■	■	—	Manual + Digital Gun Motion Control	20.4 · 24 V (110 V) 20.4 · 28 V (230 V)	16	2.4 (110 V) 5.6 (230 V)	OK	OK	49 x 37 x 30 / 14.5
<b>GYSPOT COMBI ARCPULL</b>	230V	8 m	Alu 10 · 200 Acier 3800	■	■	Steel 3800	Manual Automatic (not included)	Alu 20.4 · 28 V Steel 7.4 V	16	Alu 5.6 Steel 20	OK	OK	72 x 42 x 29 / 41.5



# DENT PULLING DRAWN ARC ALU + STEEL ACIER - STAHL

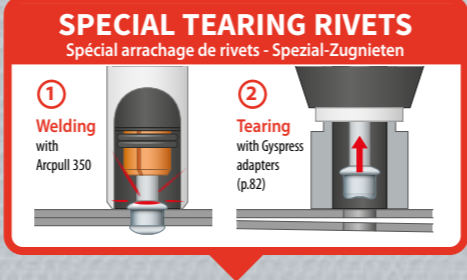

- Rings - Anneaux - Zugösen
- Start-up - Amorce - Zündung
- Hitching (l & t)
- Studs - Goujons - Gewindebolzen
- Scouring (l & t) - Décapage
- Accroche - Verklebung
- Stainless steel nails - Tiges inox
- Abbelzen
- Height - Hauteur
- Edelstahlnägel
- Abziehen
- Arc (l & t) - Arc - Lichtbogen
- Hohe



7 languages  
FR, EN, DE, SP, IT, NL & RU



∅ max  
Alu/Fe : 8 mm



∅ max  
Alu : 10 mm  
Fe : 13 mm

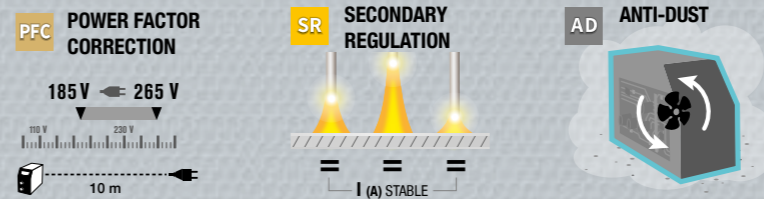

Ideal all position

5 or 10 m, ∅ 50 mm<sup>2</sup> included  
ARC PULL 700



## SYNERGIC DIGITAL GUNS

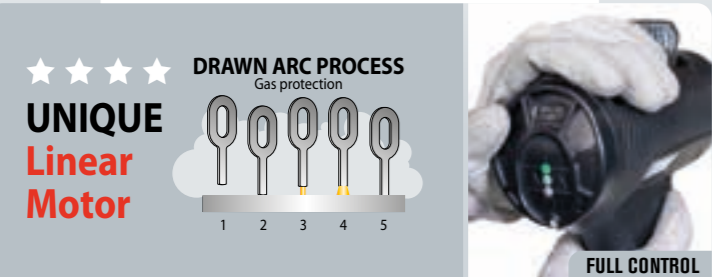

FULL CONTROL



### GYSPOT ARCPULL 350 COLLISION REPAIR

208 · 240V · 1~  
**350 A** x1 MANUAL

PFC SR AD

082953

included



### OPTIONS

details p.24



### GYSPOT ARCPULL 700 COLLISION REPAIR (5M)

380 · 480V · 3~  
**680 A** x1 MANUAL

SR IP 23

068315

### GYSPOT ARCPULL 700 COLLISION REPAIR (10M)

380 · 480V · 3~  
**680 A** x1 MANUAL

SR IP 23

085503



MADE IN FRANCE 60974-1	50/60 Hz	I <sub>2</sub> A	SYNERGIC	TECHNOLOGY		U <sub>2</sub> V	+AM- A	kW	OK	OK	LxWxH cm / kg
				Acier/Steel	Alu						
GYSPOT ARCPULL 350 COLLISION REPAIR	208 · 240V	6 m	10 · 350	■	Manual + Digital Gun Motion Control	20.4 · 34V	16	11.9	OK	OK	48 x 36 x 30 / 17.4
GYSPOT ARCPULL 700 COLLISION REPAIR	3x 400V 3x 480V	5 m	50 · 680	■	Manual + Digital Gun Motion Control	22 · 44V	20 A (D) 16 A (D)	47.8 kW 45.7 kW	OK	OK	60 x 43 x 46 / 27.8





# GYS POT ARC PULL 200, 350 & COMBI ACCESSORIES & CONSUMABLES

## ACIER / STEEL / STAHL

--	--	--	--	--	--	--	--	--	--	--	--	--	--	--	--	--	--	--	--	--	--	--	--	--	--	--	--	--	--	--	--	--	--	--	--	--	--	--	--	--	--	--	--	--	--	--	--	--	--	--	--	--	--	--	--	--	--	--	--	--	--	--	--	--	--	--	--	--	--	--	--	--	--	--	--	--	--	--	--	--	--	--	--	--	--	--	--	--	--	--	--	--	--	--	--	--	--	--	--	--	--	--	--	--	--	--	--	--	--	--	--	--	--	--	--	--	--	--	--	--	--	--	--	--	--	--	--	--	--	--	--	--	--	--	--	--	--	--	--	--	--	--	--	--	--	--	--	--	--	--	--	--	--	--	--	--	--	--	--	--	--	--	--	--	--	--	--	--	--	--	--	--	--	--	--	--	--	--	--	--	--	--	--	--	--	--	--	--	--	--	--	--	--	--	--	--	--	--	--	--	--	--	--	--	--	--	--	--	--	--	--	--	--	--	--	--	--	--	--	--	--	--	--	--	--	--	--	--	--	--	--	--	--	--	--	--	--	--	--	--	--	--	--	--	--	--	--	--	--	--	--	--	--	--	--	--	--	--	--	--	--	--	--	--	--	--	--	--	--	--	--	--	--	--	--	--	--	--	--	--	--	--	--	--	--	--	--	--	--	--	--	--	--	--	--	--	--	--	--	--	--	--	--	--	--	--	--	--	--	--	--	--	--	--	--	--	--	--	--	--	--	--	--	--	--	--	--	--	--	--	--	--	--	--	--	--	--	--	--	--	--	--	--	--	--	--	--	--	--	--	--	--	--	--	--	--	--	--	--	--	--	--	--	--	--	--	--	--	--	--	--	--	--	--	--	--	--	--	--	--	--	--	--	--	--	--	--	--	--	--	--	--	--	--	--	--	--	--	--	--	--	--	--	--	--	--	--	--	--	--	--	--	--	--	--	--	--	--	--	--	--	--	--	--	--	--	--	--	--	--	--	--	--	--	--	--	--	--	--	--	--	--	--	--	--	--	--	--	--	--	--	--	--	--	--	--	--	--	--	--	--	--	--	--	--	--	--	--	--	--	--	--	--	--	--	--	--	--	--	--	--	--	--	--	--	--	--	--	--	--	--	--	--	--	--	--	--	--	--	--	--	--	--	--	--	--	--	--	--	--	--	--	--	--	--	--	--	--	--	--	--	--	--	--	--	--	--	--	--	--	--	--	--	--	--	--	--	--	--	--	--	--	--	--	--	--	--	--	--	--	--	--	--	--	--	--	--	--	--	--	--	--	--	--	--	--	--	--	--	--	--	--	--	--	--	--	--	--	--	--	--	--	--	--	--	--	--	--	--	--	--	--	--	--	--	--	--	--	--	--	--	--	--	--	--	--	--	--	--	--	--	--	--	--	--	--	--	--	--	--	--	--	--	--	--	--	--	--	--	--	--	--	--	--	--	--	--	--	--	--	--	--	--	--	--	--	--	--	--	--	--	--	--	--	--	--	--	--	--	--	--	--	--	--	--	--	--	--	--	--	--	--	--	--	--	--	--	--	--	--	--	--	--	--	--	--	--	--	--	--	--	--	--	--	--	--	--	--	--	--	--	--	--	--	--	--	--	--	--	--	--	--	--	--	--	--	--	--	--	--	--	--	--	--	--	--	--	--	--	--	--	--	--	--	--	--	--	--	--	--	--	--	--	--	--	--	--	--	--	--	--	--	--	--	--	--	--	--	--	--	--	--	--	--	--	--	--	--	--	--	--	--	--	--	--	--	--	--	--	--	--	--	--	--	--	--	--	--	--	--	--	--	--	--	--	--	--	--	--	--	--	--	--	--	--	--	--	--	--	--	--	--	--	--	--	--	--	--	--	--	--	--	--	--	--



# FAST DENT PULLING

## STEEL / ACIER / STAHL

### EASY TOOL CONNECTION



for GYSPOT 39.02/04, PRO 230/400, EXPERT 230/400, COMBISPOT 230

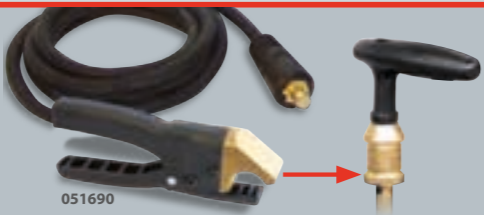

051690

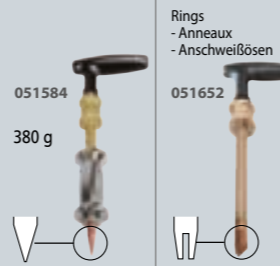

051584  
380 g

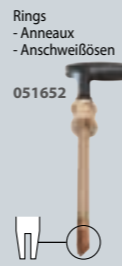

051652

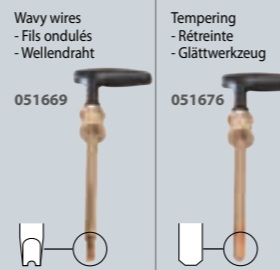

051669

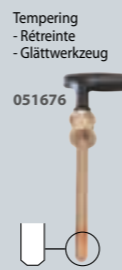

051676



Manual dent-pulling bar - Poignée de tirage manuel 057289



EASYGUN 051317



Box of 3 electrodes for accessories 050822

### MANUSPOT = 050679



Tools set and support for DENT 600, 800, 1000, 1600, Workstation & Dentstation



EASYGUN 051317



MANULINER 050471

3 m Ø 35 mm2

PATENTS REGISTERED NUMBERS 001652108-0003 EUROPEAN TRADEMARK & DESIGN

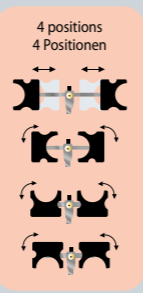

4 positions 4 Positionen

### FAST & EASY



RINGMATIC 052154

included (x 50)



Option Gun adapter - Adaptateur pistolet 052499

### MANULINER/GUN 056831

PATENTS REGISTERED NUMBERS 001652108-0003 EUROPEAN TRADEMARK & DESIGN



Pads - Patins (x2) 060807



Gun adapter - Adaptateur pistolet included 052499

### DENT AXE PULLER 080508



Direct impact electrodes (x5) 050839

### QUICK SPOT AIR GUN V2 057340



LIGHT 920 g

AIR

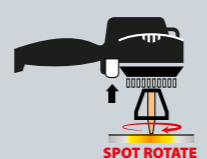

SPOT ROTATE

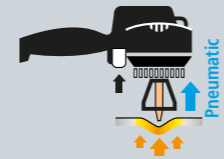

Pneumatic



Gun adapter - Adaptateur pistolet 052826

### MANU PULLER 079502



Included Alu 3 065178

Included Steel 079830

Included Alu 4 065185

## ALU

### ARC PULLER PREMIUM 065161

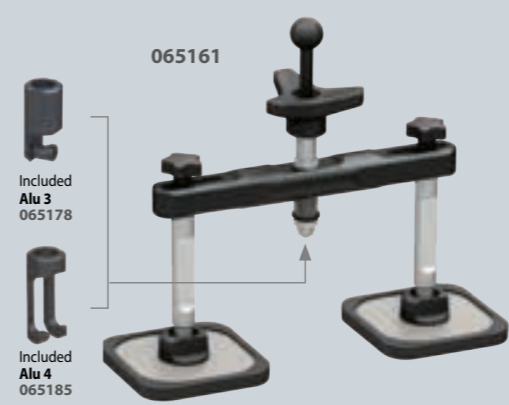

Included Alu 3 065178

Included Alu 4 065185

Pads - Patins (x2) 069008

ULTRA RESISTANT No deformation

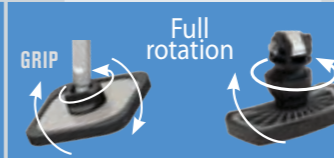

Full rotation



Multi positions

### ARC PULLER PREMIUM PRO 072572



Pads - Patins (x4) 074958

Included Alu 3 065178

Included Alu 4 065185

## ALU PULLER

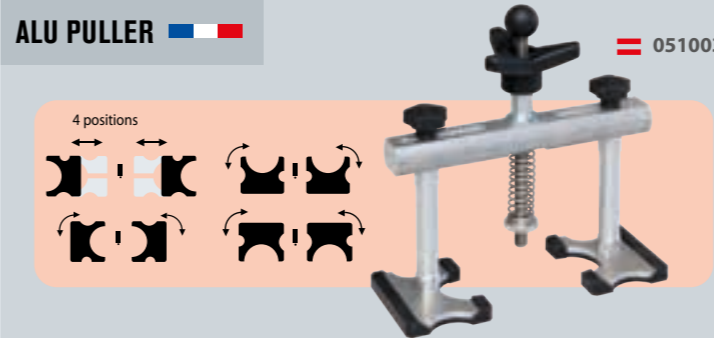

4 positions

= 051003

Included Alu 1 050938

Included Alu 2 050945

Patins - Pads (x2) 060807

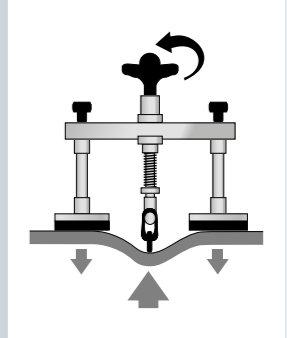

### STRAIGHT LINE LAMP - Lampe ligne droite - Dentline-laser 056770



### FAST PULLING RINGS - Anneaux de tirage rapide 058743

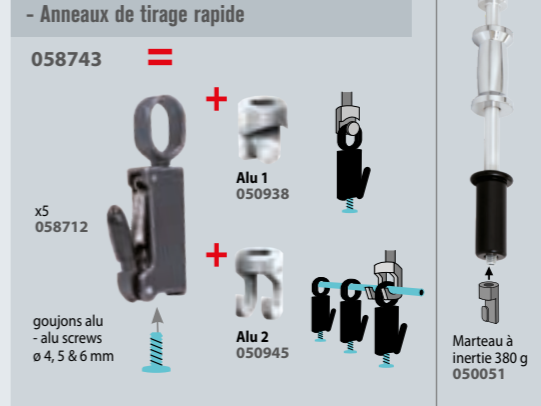

x5 058712

Alu 1 050938

Alu 2 050945

goujons alu - alu screws ø 4, 5 & 6 mm

### ALU HAMMERS - Marteaux alu 020986



Marteau à inertie 380 g 050051

### Heat gun - Décapeur thermique - Heißluftpistole 066311

I: 100/300°C (450 W)  
II: 300/650°C (1500 W)  
Air flow: 450 l/min



230 V only

Affichage digital Digital display

### Gas hot air gun - Pistolet à air chaud autonome à gaz 060777

Bouteille de gaz incluse, gas cylinder included



### Blow torch - Lampe à souder - Lötlimpe 052741

HIGH QUALITY



### Novacet+ (Butane/propane/propylene) 380 ml/220 g 040441

Brushes - Brossen - Bürsten - Brosses - Cepillos



### Thermal marking pencil - Crayon marqueur thermique 052765

121°C / 250°F

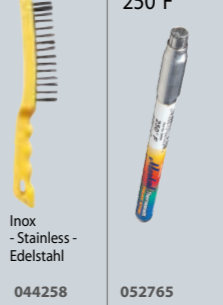

### Freezer spray - Spray refroidisseur 048898

-50°C 400 ml

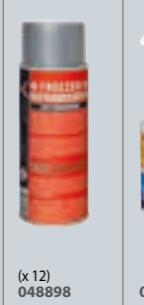

### Heat barrier spray - Spray barrière thermique 054325

Adjustable emissivity: 0.10 ~ 1.00



### Infrared Thermometer - Thermomètre infrarouge 079922

-50 / +600°C  
-58 / +1112°F



# PULLING BARS

## 3 PRODUCT LINES

### 1 STANDARD

### 2 PREMIUM

### 3 PREMIUM PRO



## STANDARD

**Levelling lever**  
- Levier de débosselage  
- Zughebel

**050686**  
↓ 1.6 kg  
⊗ 79 x 12 x 17 cm / 1.9 kg

PATENTS REGISTERED NUMBERS  
001652108-0002  
EUROPEAN TRADEMARK & DESIGN

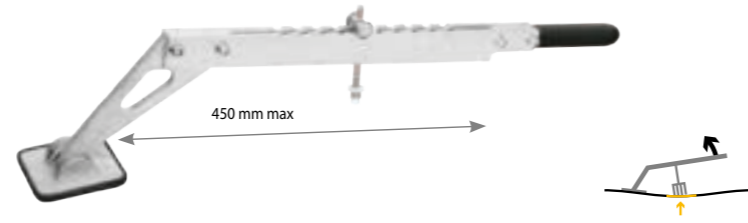

**Double action levelling bar**  
- Barre de débosselage double action  
- Zughebelbrücke

**053564**  
↓ 2.5 kg  
⊗ 77 x 12 x 13 cm / 3.2 kg

Licensed by  
BETAG.Innovation

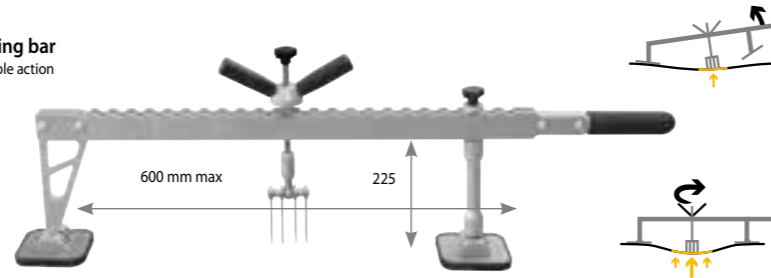

**Levelling bar**  
- Barre de débosselage  
- Zugbrücke

**050693**  
↓ 3.4 kg  
⊗ 87 x 17 x 19 cm / 4 kg

Licensed by  
BETAG.Innovation

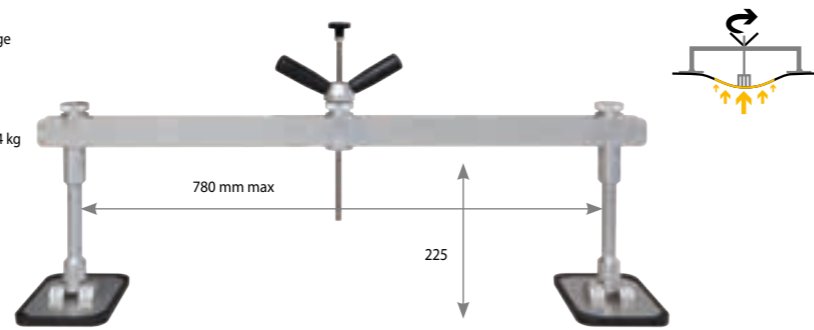

**Reinforced scissoring bar**  
- Barre de tirage renforcée  
- Scherenzugbrücke

**050716**  
↓ 5.1 kg  
⊗ 87 x 17 x 18 cm / 5.9 kg

PATENTS REGISTERED NUMBERS  
001652108-0001  
EUROPEAN TRADEMARK & DESIGN

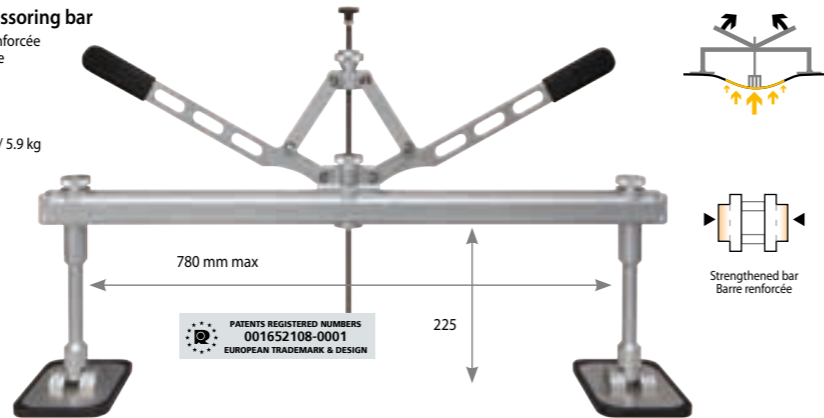

## SLIDE & LOCK

Removable system : pads and pulling systems  
Système amovible : patins et chariots de tirage

### FEET



### PULLING SYSTEM

only for 059313



## LIGHTWEIGHT

Léger



### GRIP 360

360° pads with grip  
Patins à frein orientables à 360°



### X-CROSS

Possibility of crossing the bars  
Possibilité de croiser les barres

## PREMIUM

**Premium levelling lever**  
- Levier de débosselage Premium  
- Premium Zughebel

**059290**  
↓ 1.6 kg  
⊗ 100 x 16 x 17 cm / 2.2 kg

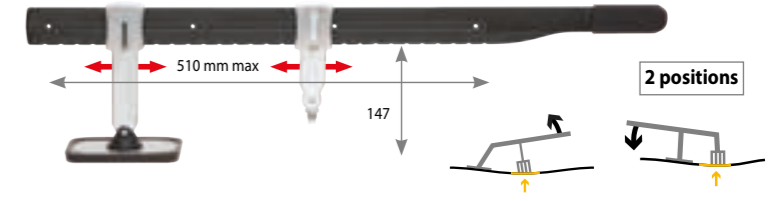

**Premium levelling bar**  
- Barre de débosselage Premium  
- Premium Zugbrücke

**059306**  
↓ 2.8 kg  
⊗ 79 x 30 x 13 cm / 3.2 kg

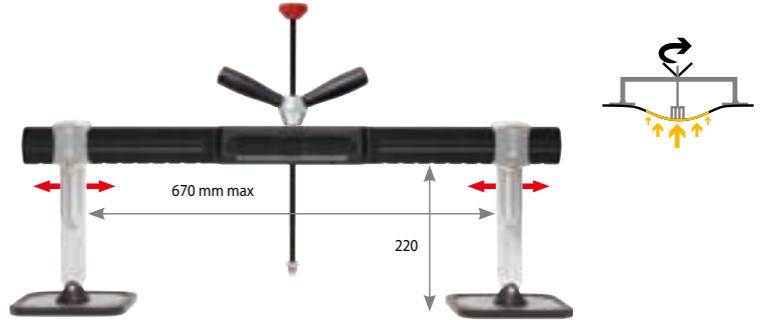

**Premium scissoring bar**  
- Barre de tirage Premium  
- Premium Scherenzugbrücke

**058996**  
↓ 3.1 kg  
⊗ 87 x 16 x 18 cm / 3.9 kg

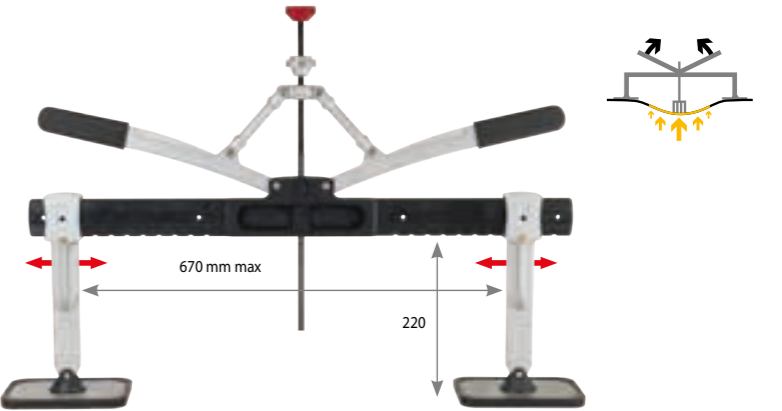

**Premium 1200 scissoring bar**  
- Barre de tirage 1200 renforcée Premium  
- Premium Scherenzugbrücke 1200

**059313**  
↓ 5.6 kg  
⊗ 127 x 26 x 9 cm / 6.2 kg

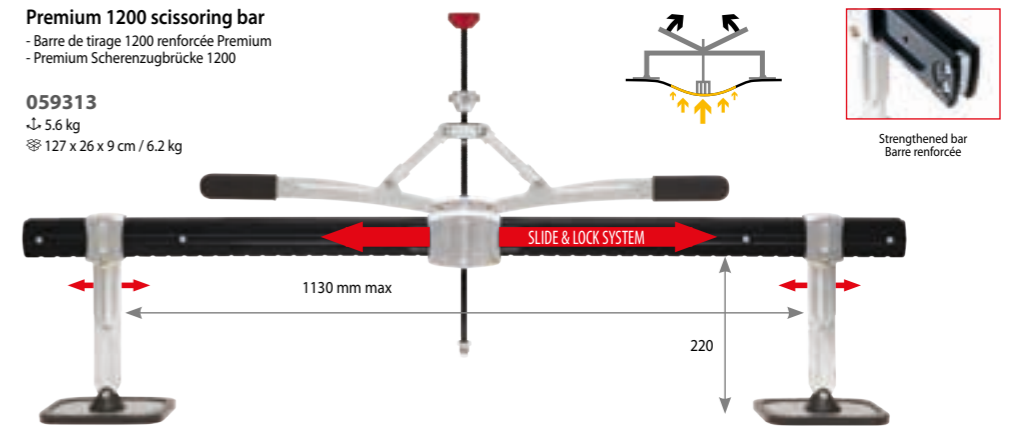

## OPTIONS

**Reinforced bar 1200 mm - Barre renforcée**  
051171

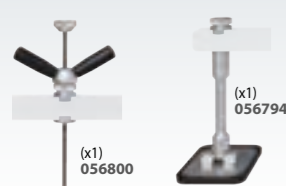
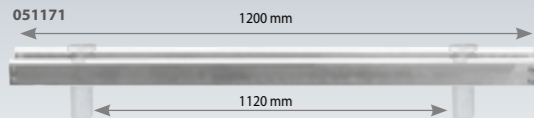

Fixing screw  
058439

**Double pads support**  
- Support double patin  
- DoppelfüÙe  
050723

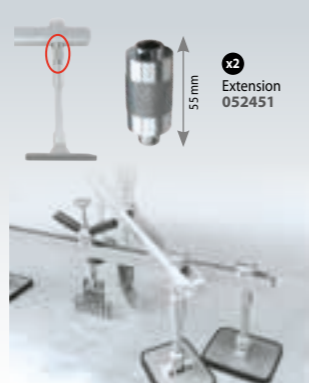

STANDARD  
PREMIUM

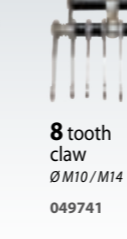
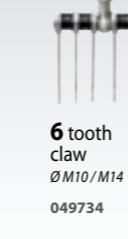
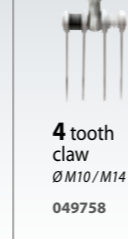

**Single foot**  
- Pied simple  
- Fuß

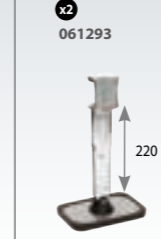

**Double foot levelling bar**  
- Pied double patin  
- Doppelfuß

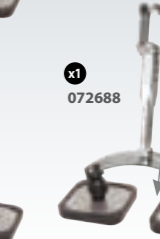
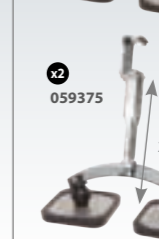

069268



## OPTIONS

**QUICK HOOK**

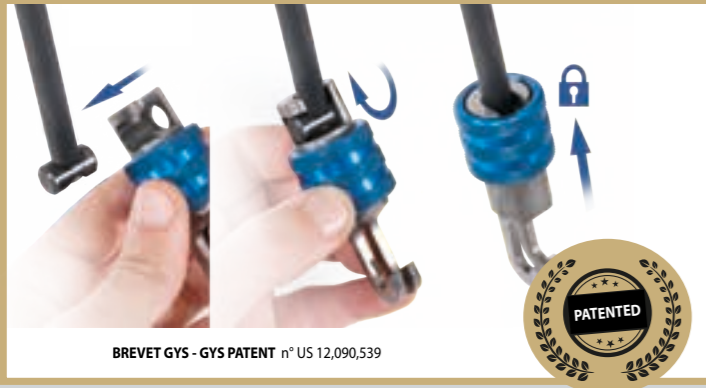

BREVET GYS - GYS PATENT n° US 12,090,539



**SLIDE & LOCK**

Removable system : pads and pulling systems  
Système de patins et chariots de tirage amovibles



**PULLING SYSTEM**

**FEET**

**EASY REMOVABLE PULLING SYSTEM**

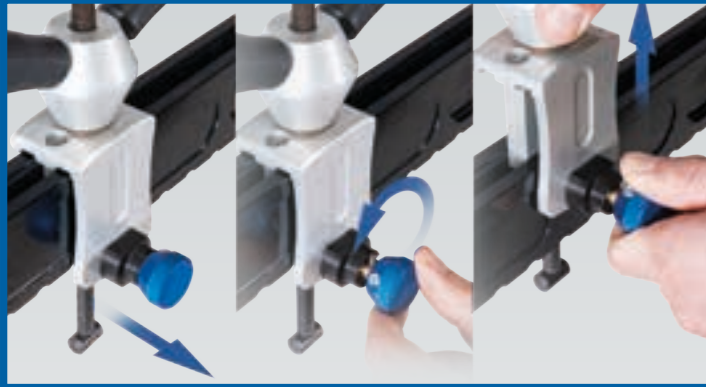

**MULTIPLE PULLING SYSTEM**

Additional removable pulling systems  
Chariots de tirage amovible supplémentaire



**X-CROSS**

Possibility of crossing the bars  
Possibilité de croiser les barres



**GRIP 360**

**GRIP 360+**



360° pads with grip  
Patins à frein orientables à 360°

**STRENGTHENED (DOUBLE) BAR**

Improved mechanical resistance  
Résistance mécanique renforcée



**Premium Pro Levelling lever**

- Levier de débosselage Premium Pro  
- Premium Pro Zughebel

**072619**

↳ 1.6 kg  
⊗ 87 x 17 x 18 cm / 2.3 kg

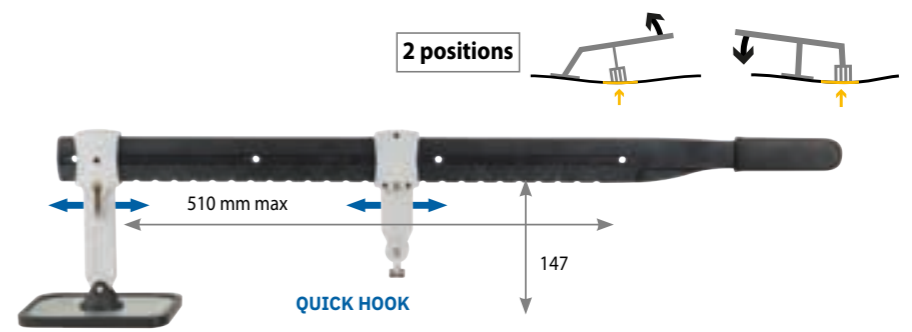

**Premium Pro Levelling bar 900mm / Single feet**

- Barre de débosselage Premium Pro 900 mm  
- Premium Pro Zugbrücke 900 mm

**071643**

⊗ 120 x 26 x 8 cm / 4.4 kg  
↳ 3.8 kg

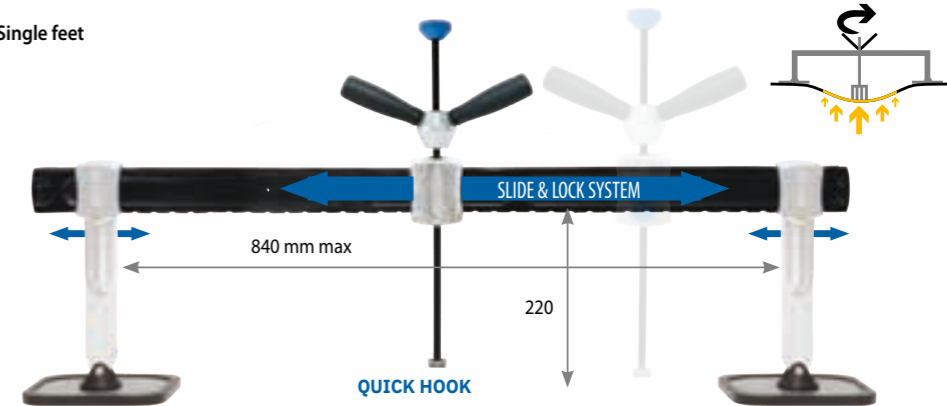

**Premium Pro Scissoring bar 900mm**

- Barre de tirage Premium Pro 900 mm  
- Premium Pro Scherenzugbrücke 900 mm

**072305**

⊗ 103 x 30 x 13 cm / 5.2 kg  
↳ 4.5 kg

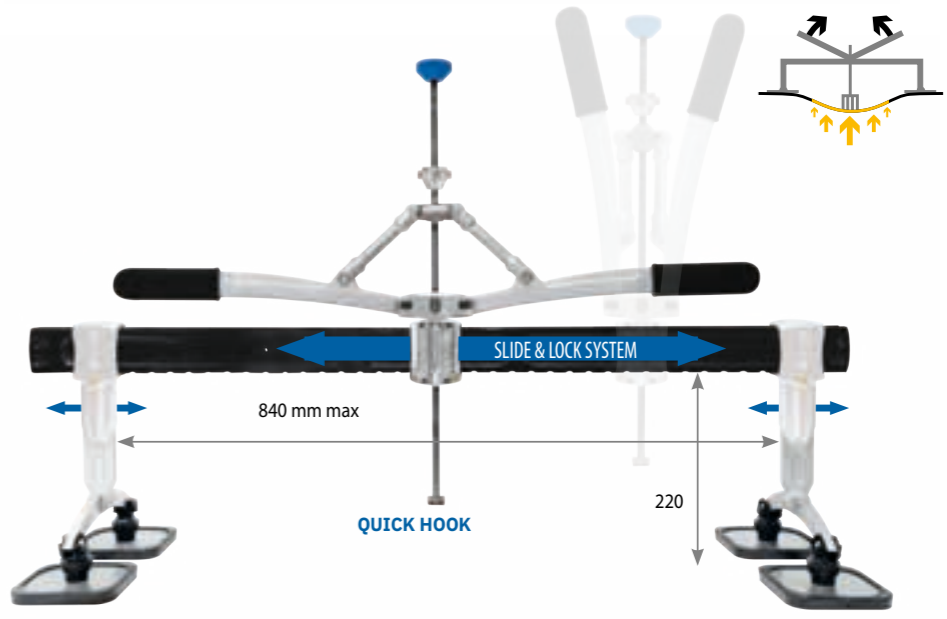

**Premium Pro Scissoring bar 1150 mm**

- Barre de tirage Premium Pro 1150 mm  
- Premium Pro Scherenzugbrücke 1150 mm

**072626**

⊗ 124 x 7 x 7 cm / 3.1 kg



**OPTIONS**

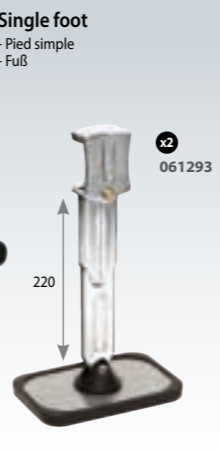
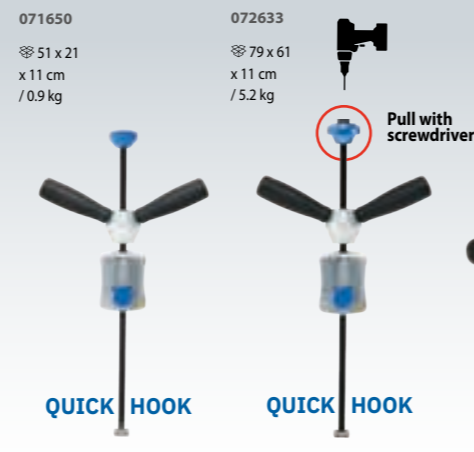
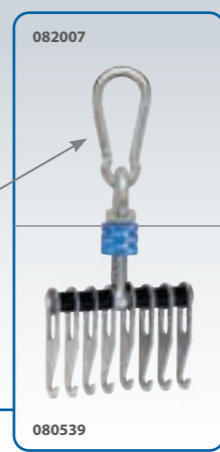
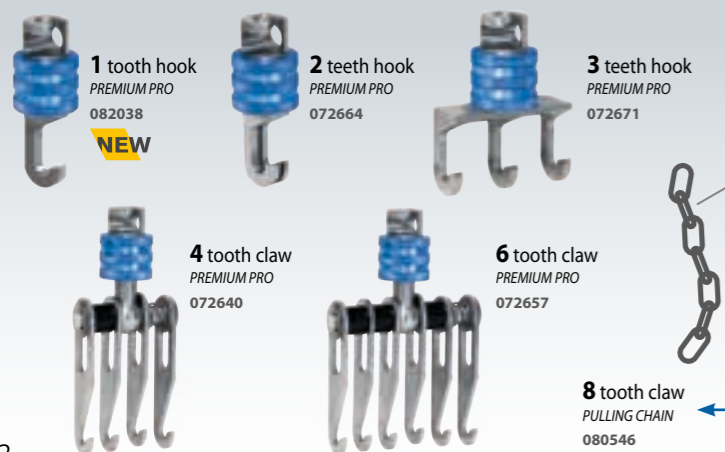



# DENT PULLING WORKSTATIONS

A COMPLETE SOLUTION  
UNE SOLUTION COMPLÈTE  
KOMPLETTLÖSUNGEN

## Compatibility

SPOT	Dent 600	Dent 1000	Universal 800	Weld 810	Weld 910	Dent 1600	Dent 1600 WD	Dentstation Pro WD
26/27.02	✓	✓	✓	✓		✓		✓
34.02/04	✓	✓	✓	✓		✓		✓
39.02/04	✓	✓	✓	✓		✓		✓
PRO 230/400	✓	✓	✓	✓		✓		✓
EXPERT 230/400	✓	✓	✓	✓		✓		✓
ALU 66	✓	✓	✓					
ALU PRO FV	✓	✓	✓			✓		✓
COMBI 230 E.PRO						✓		✓
ARCPULL 200/350				✓	✓	✓		✓
COMBI ARCPULL						✓		✓
ARCPULL 700					✓	✓		✓

## CHARIOTS / TROLLEYS

Dent 600  
44 x 35 x 62 cm / 6,9 kg  
60 x 39 x 14 cm / 7,4 kg  
072831

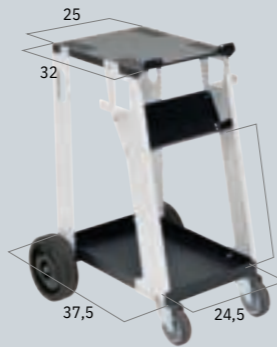

Dent 1000  
44 x 35 x 98 cm / 9,3 kg  
60 x 39 x 14 cm / 9,9 kg  
072848

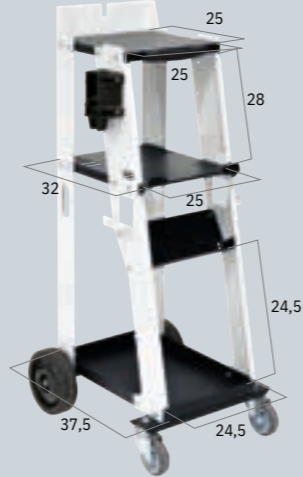

Universal 800  
60 x 48 x 83 cm  
17,6 kg  
79 x 39 x 18 cm  
18,1 kg  
051331

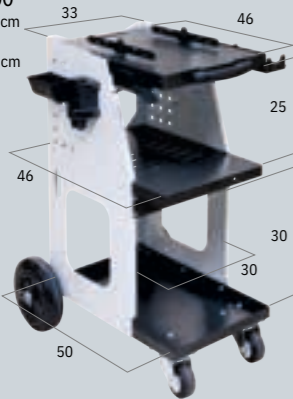

Weld 810  
77 x 50 x 84 cm  
20,1 kg  
80 x 51 x 14 cm  
21,6 kg  
037489

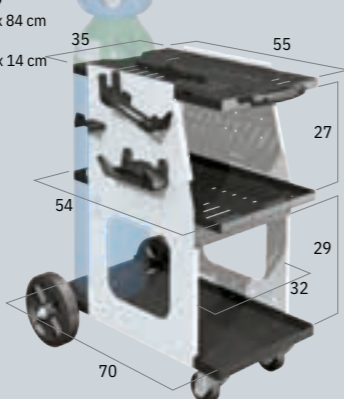

Weld 910  
89 x 52 x 84 cm  
25 kg  
80 x 52 x 22 cm  
27 kg  
070967

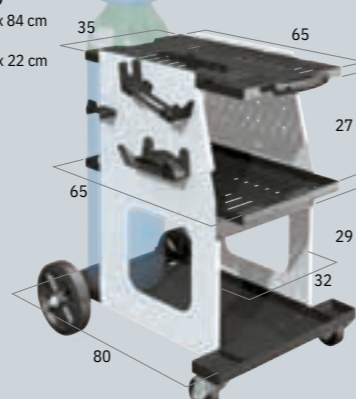

Dent 1600  
70 x 69 x 161 cm  
35,8 kg  
103 x 66 x 22 cm  
38,7 kg  
072596

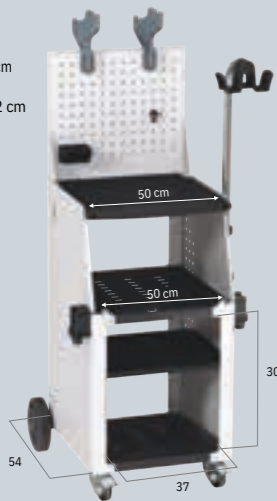

Dent 1600 WD  
71 x 70 x 161 cm  
49,5 kg  
103 x 66 x 22 cm  
52,4 kg  
072169

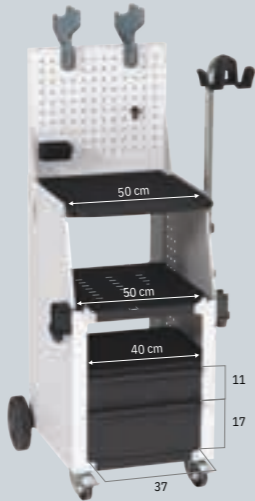

Dentstation Pro WD  
90 x 71 x 161 cm  
65 kg  
120 x 80 x 28 cm  
68,5 kg  
072800



Cable support for Spot 800, 1600 & Dentstation 052284



Protection cover - Housse de protection - Schutzhaube  
for Universal 800 062733  
for Spot 1600 & Dent 1600 048881  
for Dentstation Pro 059870

Storage accessories - Set de fixation x 6  
for Proliner, Speedliner, Gysliner 051362  
Fixing flanges for generator - Brides de fixation pour générateur x 2  
062146

## EASYLINER



EASYLINER 39.02 EASYLINER PRO 230

## PROLINER



PROLINER 39.02 PROLINER PRO 230 PROLINER PRO 400 PROLINER ALU 66 PROLINER ALU PRO FV PROLINER ARCPULL 200

### STEEL / ACIER / STAHL



GYS SPOT (guns & consumables included)

### STEEL / ACIER / STAHL



GYS SPOT (guns & consumables included)

### ALU



GYS SPOT (guns & consumables included)

39.02	PRO 230	39.02	PRO 230	ALU 66	ALU PRO FV	ARCPULL 200
053618 058521	072398	035775	035799	087774	035836	065260



### INCLUDED ACCESSORIES



Dent 1000 072848 Dent box easy 053632

### INCLUDED ACCESSORIES



UNIVERSAL 800 051331 + Cable support 052284 Dent box easy 050037



Levelling bar double action 053564

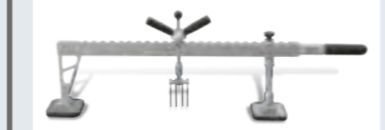

Levelling bar double action 053564



UNIVERSAL 800 051331 + Cable support 052284



UNIVERSAL 800 051331 + Cable support 052284

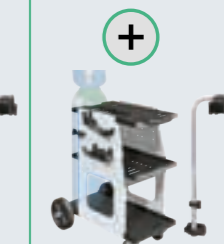

Weld 810 037489 + Cable support 052284



Alu puller 051003



Alu puller 051003



Arc puller premium 065161

# SPEEDLINER STANDARD

\*\*\*  
COMPLETE  
SYSTEM



PRO 230, 400      EXPERT 200, 230, 400      COMBI 230 E.PRO      ARCPULL 200 + PRO 230, 400      ARCPULL 200 + EXPERT 200, 230, 400      ALU PRO FV

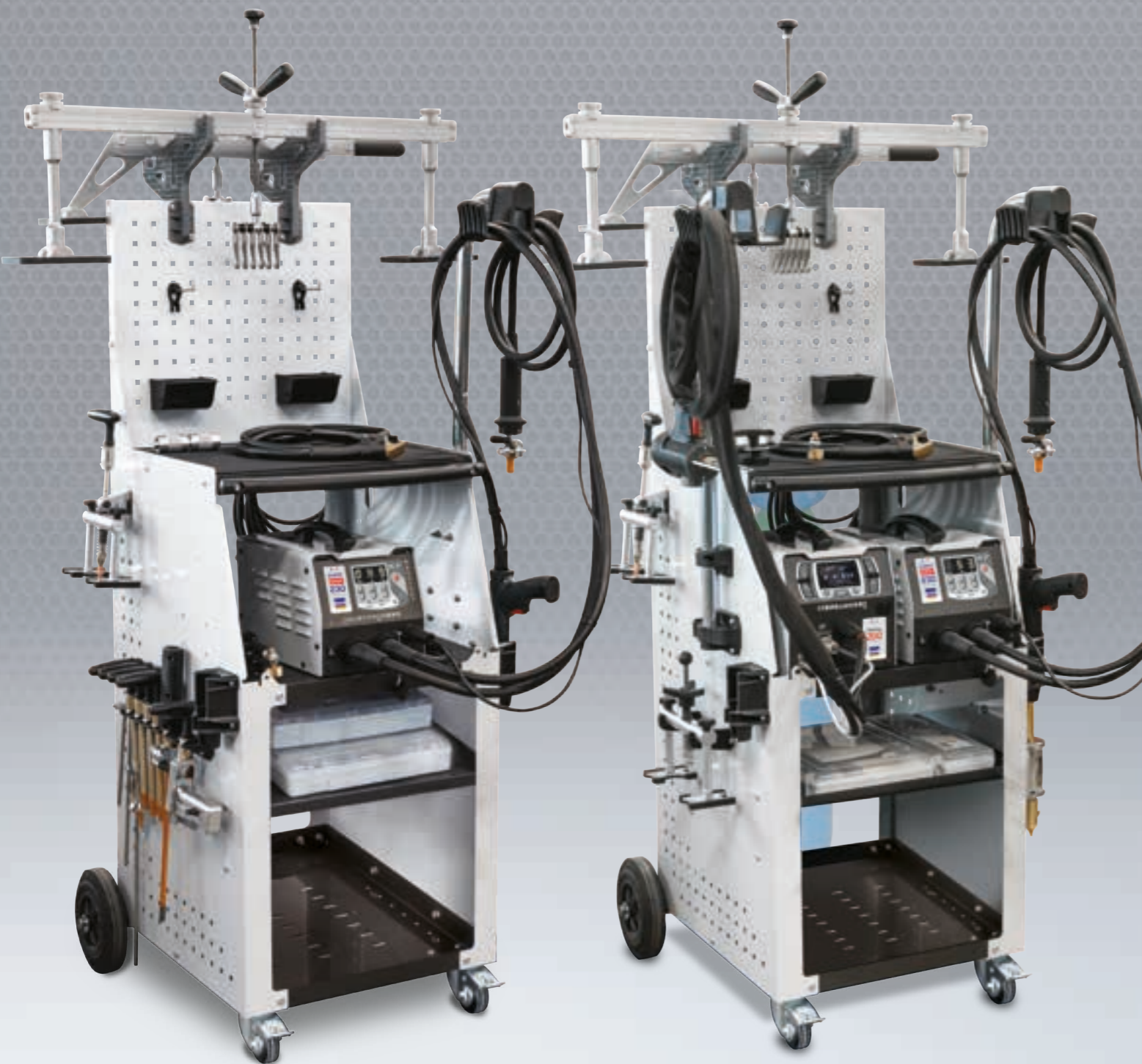

## STEEL / ACIER / STAHL



GYSPT  
(guns & consumables included)



GYSPT  
(guns & consumables included)



GYSPT  
(guns & consumables included)

## ALU



GYSPT  
(guns & consumables included)

PRO 230 074446	EXPERT 200 074460	COMBI 230 E PRO 074491	ARCPULL 200 + PRO 230 074507	ARCPULL 200 + EXPERT 200 074521	ALU 66 087781	ALU PRO FV 074552
PRO 400 074453	EXPERT 230 074477		ARCPULL 200 + PRO 400 074514	ARCPULL 200 + EXPERT 230 074538		
	EXPERT 400 074484			ARCPULL 200 + EXPERT 400 074545		

### INCLUDED ACCESSORIES

DENT 1600 072596	Cable support 052284	Levelling bar 850 mm 050693	Levelling lever 050686
Magnetic earth 049666	Manuspot 050679	Dent box consumables 051515 3 lifting rods 050792	Ringmatic 052154
Alu puller 051003	Cable support 052284	Arc puller premium 065161	Cable support 052284 + 4 m support 059665

### INCLUDED ACCESSORIES

DENT 1600 072596	Cable support 052284
Levelling bar 850 mm 050693	Levelling bar 850 mm 050693
Alu hammers 020986	Set of pencil punches with 6 teflon tips 052888
Multihook heads 049758	Alu puller 051003
Stainless steel brush 044258 Alu Box Ø5 & 6 048195	Infrared Thermometer 079922 Hot air gun 650°C 066311

Steel Speedliner without generator (excluded Ringmatic) : 035058

# SPEEDLINER PREMIUM

★★★★  
COMPLETE SYSTEM



PRO 230, 400



EXPERT 200, 230, 400

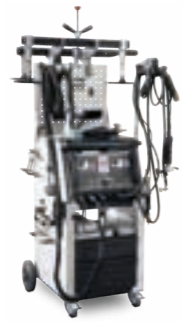

COMBI 230 E.PRO

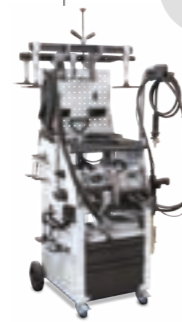

ARCPULL 200  
+ PRO 230, 400



ARCPULL 200  
+ EXPERT 200, 230, 400



ARCPULL 200, 350



## STEEL / ACIER / STAHL



GYSPOT  
(guns & consumables included)



GYSPOT  
(guns & consumables included)



GYSPOT  
(guns & consumables included)

## ALU



GYSPOT  
(guns & consumables included)



GYSPOT  
(guns & consumables included)

<b>PRO 230</b> 073883	<b>EXPERT 200</b> 073906	<b>COMBI 230 E PRO</b> 073968	<b>COMBI ARCPULL</b> 074569	<b>ARCPULL 200 + PRO 230</b> 073975	<b>ARCPULL 200 + EXPERT 200</b> 073913	<b>ARCPULL 200</b> 073999	<b>ARCPULL 350</b> 083042
<b>PRO 400</b> 073890	<b>EXPERT 230</b> 073920			<b>ARCPULL 200 + PRO 400</b> 073982	<b>ARCPULL 200 + EXPERT 230</b> 073937	077317 (without HOT AIR GUN)	
	<b>EXPERT 400</b> 073944				<b>ARCPULL 200 + EXPERT 400</b> 073951		

### INCLUDED ACCESSORIES

DENT 1600 WD 072169	Cable support 052284	Premium levelling bar 720 mm 059306
Hook head 049758 + 059658 + 082021	Premium levelling lever 059290	
Magnetic earth 049666	Manuspot 050679	Dent box consumables 051515 + 3 lifting rods 050792
	Manual pulling handle 057289 Ringmatic 052154	Alu hammers 020986

+

Fast pulling rings (x5) 058712 + Alu puller 051003 + Cable support 052284

+

Arc puller premium 065161	Cable support 052284 4 m <sup>2</sup> support 059665

### INCLUDED ACCESSORIES

DENT 1600 WD 072169 Cable support 052284	Alu Ring Box 1 mm 059412 Premium 1-tooth hook 059382
Arc puller premium 065161	Premium levelling bar 720 mm 059306
Alu hammers 020986	Infrared Thermometer 079922 Hot air gun 650°C 066311
Set of pencil punches with 6 teflon tips 052888	3 lifting rods 050792
Stainless steel brush 044258	4 m <sup>2</sup> support 059665

# SPEEDLINER PREMIUM PRO



PRO 230, 400

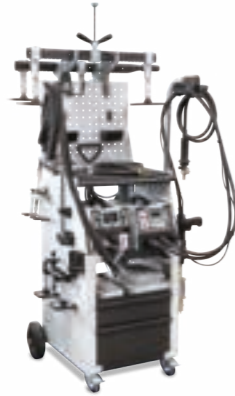

EXPERT 200, 400  
+ ARCPULL 200, 350

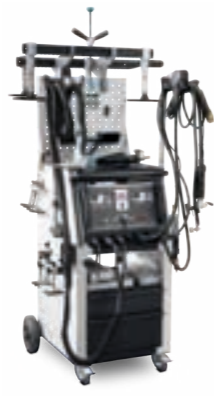

COMBI ARCPULL



ARCPULL 200, 350

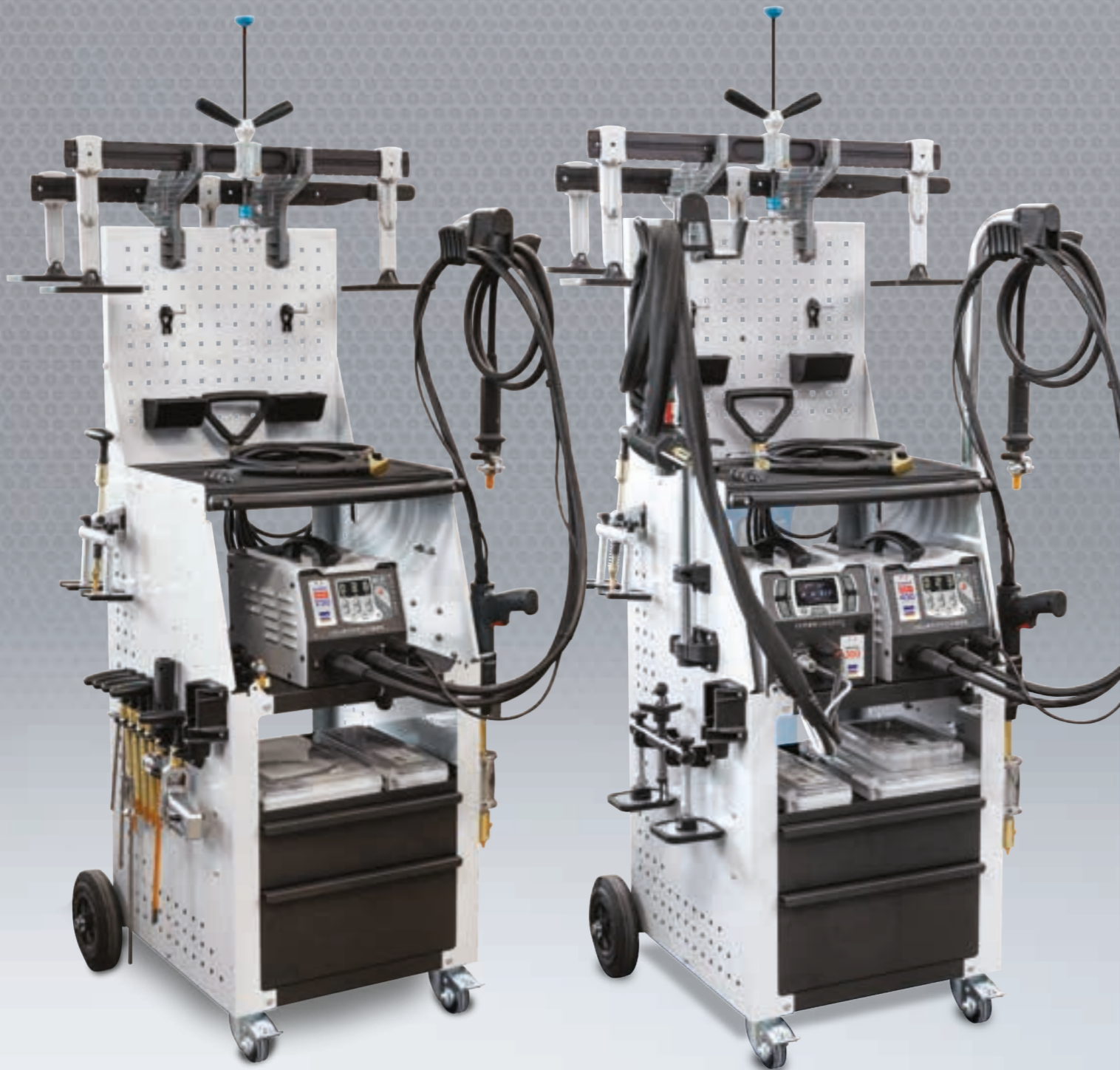

## STEEL / ACIER / STAHL



GYSPOT  
(guns & consumables included)

## ALU + STEEL / ACIER / STAHL



GYSPOT  
(guns & consumables included)



GYSPOT  
(guns & consumables included)

## ALU



GYSPOT  
(guns & consumables included)

EXPERT 230 080201	EXPERT 400 080218	EXPERT 400 + ARCPULL 200 080232	EXPERT 400 + ARCPULL 350 083028	COMBI ARCPULL 080225	ARCPULL 200 080256	ARCPULL 350 083035
		EXPERT 200 + ARCPULL 200 080553				

### INCLUDED ACCESSORIES

+	

### INCLUDED ACCESSORIES



# DENTSTATION STANDARD



39.02, 39.04      PRO 230, 400      EXPERT 200, 230, 400      COMBI 230 E.PRO      ARCPULL 200 + PRO 230, 400      ARCPULL 200 + EXPERT 200, 230, 400

## STEEL / ACIER / STAHL



GYSPOT  
(guns & consumables included)

## ALU + STEEL / ACIER / STAHL



GYSPOT  
(guns & consumables included)

GYSPOT  
(guns & consumables included)

39.02	PRO 230	EXPERT 200	COMBI 230 E PRO	ARCPULL 200 + PRO 230	ARCPULL 200 + EXPERT 200
078161	078208	078321	078529	078222	078338
39.04	PRO 400	EXPERT 230		ARCPULL 200 + PRO 400	ARCPULL 200 + EXPERT 230
078185	078260	078369		078284	078383
		EXPERT 400 078444			ARCPULL 200 + EXPERT 400 078468



### INCLUDED ACCESSORIES

<p>Dentstation Pro WD 072800 Fixing kit 051362</p>	<p>Double pads 050723</p>	<p>Levelling bar 850 mm 050693</p>	<p>Scissoring bar 050716</p>
<p>Magnetic earth 049666</p>	<p>Multihook heads 049758 +049734 +049741</p>	<p>Levelling lever 050686</p>	<p>Strengthened bar 1200 mm 051171 Extensions (x2) 052451</p>
<p>Fast pulling rings (x5) 058712 + Alu puller 051003</p>	<p>Manuspot 050679</p>	<p>Dent box consumables 051515 3 lifting rods 050792 Empty box 320x113mm</p>	<p>Manual pulling handle 057289</p>
<p>Cable support 052284</p>	<p>Arc puller premium 065161</p>	<p>Cable support 052284 + 4 m support 059665 + Flanges (x 2) 062146</p>	

# DENTSTATION PREMIUM



PRO 230, 400



EXPERT 200, 230, 400



COMBI 230 E.PRO  
COMBI ARCPULL



ARCPULL 200  
+ PRO 230, 400



ARCPULL 200  
+ EXPERT 200, 230, 400

★★★★  
COMPLETE  
SYSTEM

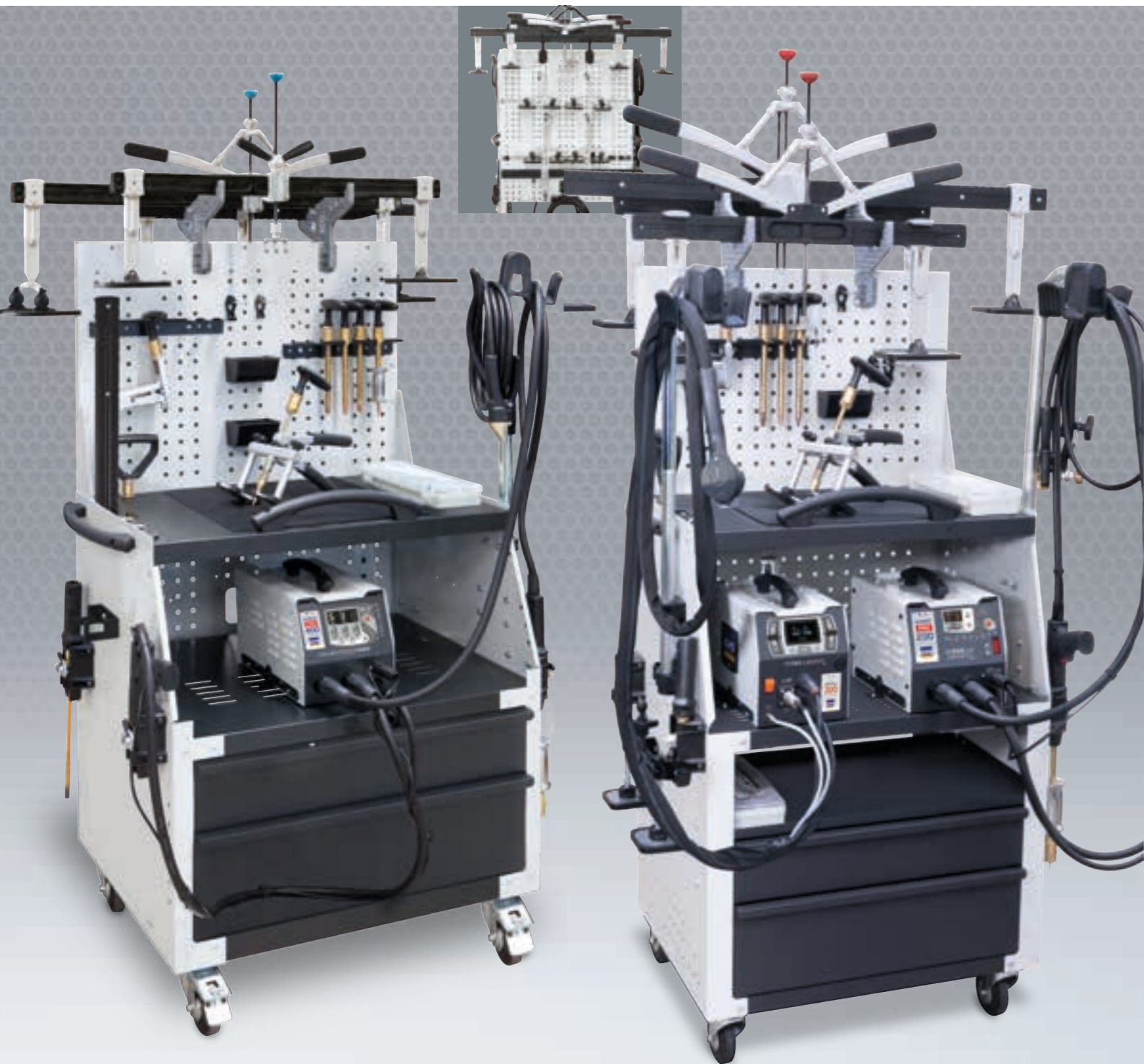

## STEEL / ACIER / STAHL



GYSPOT  
(guns & consumables included)

## ALU + STEEL / ACIER / STAHL



GYSPOT  
(guns & consumables included)



GYSPOT  
(guns & consumables included)

<b>PRO 230</b> 078239	<b>EXPERT 200</b> 078345	<b>COMBI 230 E PRO</b> 078543	<b>COMBI ARCPULL</b> 078567	<b>ARCPULL 200 + PRO 230</b> 078253	<b>ARCPULL 200 + EXPERT 200</b> 078352
<b>PRO 400</b> 078291	<b>EXPERT 230</b> 078406			<b>ARCPULL 200 + PRO 400</b> 078314	<b>ARCPULL 200 + EXPERT 230</b> 078420
	<b>EXPERT 400</b> 078482				<b>ARCPULL 200 + EXPERT 400</b> 078505

### INCLUDED ACCESSORIES



Dentstation Pro WD  
072800  
Fixing kit  
051362



Manuspot  
050679



Premium levelling bar 720 mm  
059306



Premium levelling lever  
059290



Hook head  
049734  
+ 059658  
+ 082021



Premium scissoring bar 720 mm  
058996

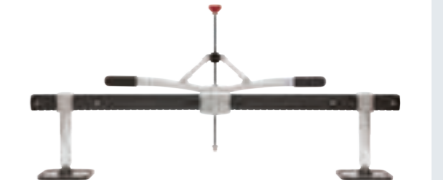

Premium scissoring bar 1200 mm  
059313



Magnetic earth  
049666



Premium double pads support  
220 mm (x2)  
059375  
+ 270 mm (x2)  
072688

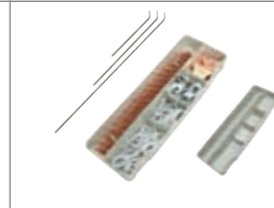

Dent box consumables  
051515  
3 lifting rods  
050792  
Empty box 320x113mm



Manual pulling handle  
057289



Ringmatic  
052154



Fast pulling rings (x5)  
058712  
Alu puller  
051003  
Cable support  
052284



Cable support  
052284  
4 m<sup>2</sup> support  
059665  
Flanges (x 2)  
062146  
Arc puller premium  
065161



Arc puller premium  
065161



Cable support  
052284  
4 m<sup>2</sup> support  
059665  
Flanges (x 2)  
062146

# DENTSTATION PREMIUM PRO



EXPERT 230, 400



COMBI ARCPULL



EXPERT 400 + ARCPULL 200, 350



ARCPULL 200, 350

## STEEL / ACIER / STAHL



1 BOX GYS POT (guns & consumables included)

## ALU + STEEL / ACIER / STAHL



1 BOX GYS POT (guns & consumables included)

## ALU



1 BOX GYS POT (guns & consumables included)

EXPERT 230 080133	EXPERT 400 080140	EXPERT 400 + ARCPULL 200 080164	EXPERT 400 + ARCPULL 350 083004	COMBI ARCPULL 080157	ARCPULL 200 080461	ARCPULL 350 083011
----------------------	----------------------	------------------------------------	------------------------------------	-------------------------	-----------------------	-----------------------

### INCLUDED ACCESSORIES



1 BOX Dentstation Pro WD 072800



Premium pro levelling bar 900mm 071643



Premium pro levelling lever 072619  
Premium pro bar 1184 mm 072626



Manuspot 050679

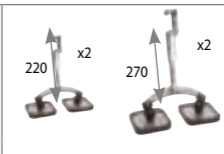

(x2) 059375 + (x2) 072688



072664 + 072671 + 072640 + 072657



071650 + 072312

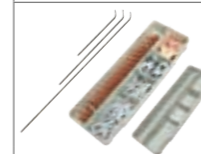

Dent box consumables 051515  
3 lifting rods 050792  
Empty box 320x113mm



Magnetic earth 049566  
Ringmatic 052154  
Manual pulling handle 057289

1 BOX STEEL ACCESSORIES PACK V2 080126



Cable support 052284



4 m³ support 059665



Arc Puller Premium Pro 072572

1 BOX ALU ACCESSORIES PACK 073838

### INCLUDED ACCESSORIES



1 BOX Dentstation Pro WD 072800



Premium pro levelling bar 900mm 071643 (x2) 059375



072664 + 072640 + 071650 Alu Ring Box 1 mm 059412



Alu hammers 020986



Arc Puller Premium Pro 072572



Set of pencil punches with 6 teflon tips 052888



3 lifting rods 050792



Stainless steel brush 044258



Infrared Thermometer 079922



Hot air gun 650°C 066311

1 BOX ARCPULL ACCESSORIES PACK 080485



# PULLING SYSTEMS

AIRFIX DRAW ALIGNER	38
DRAW ALIGNER	40
FRAME STRAIGHTENING	42



## DRAW ALIGNER



Designed for

- ★ TIME SAVING
- ★ DURABILITY
- ★ MAXIMUM GRIP

4 pads :  
**Seal protection,  
Perfect stability**

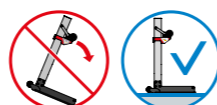

4 patins : protection du joint, stabilité parfaite  
4 Pads: Dichtungsschutz, perfekte Stabilität  
4 piedini: protezione sigillata, perfetta stabilità

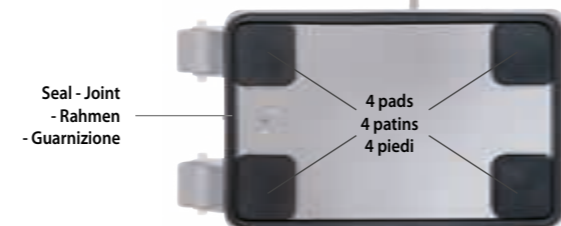

### Quick & easy set up



Compact & light  
31 kg



### Ground anchor by suction Fast installation

Ancrage au sol par aspiration : installation rapide  
Verankerung durch Vakuumbildung – schnell einsatzfähig  
Ancoraggio a terra: installazione rapida

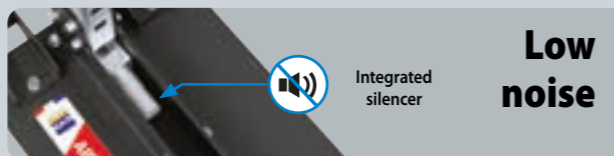
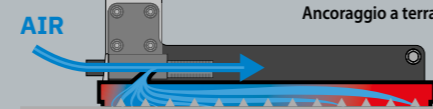

### Low noise



### Smart maintenance



- No glue
- No tools

Pads - Patins (x2) 069008

Plate seal - Joint de plaque 079571



## AIRFIX DRAW ALIGNER

Air 5-8 bars

077379

080669

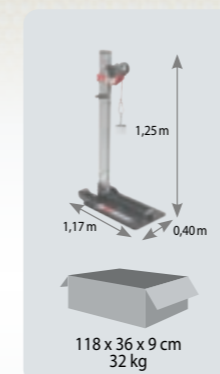

**350 kg**  
**Uniform pulling force**  
Force de tirage uniforme  
Gleichmäßige Zugkraft  
Forza di spinta uniforme

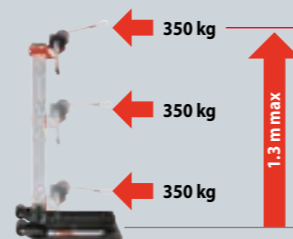

### Precision

All directions

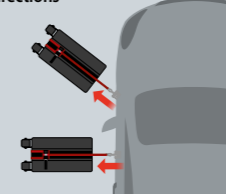

### Down-pulling

Rocker panel  
- Bas de caisse  
- Schweller  
- Sottoporta



### Up-pulling

Upper-parts  
- Parties hautes  
- Oberteile

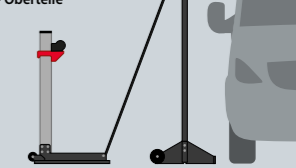

### Options

Welding sheets kit  
- Kit plaques à souder  
083493

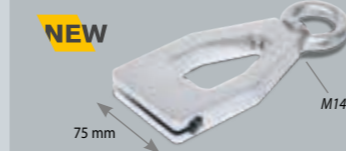

<b>25 mm</b> (x1 included)	<b>38 mm</b> (x1 included)	<b>50 mm</b> (x1 included)	<b>75 mm</b> (x1 included)
x5 083509	x5 083516	x5 083523	x5 083530

12 tooth claw  
- Griffes 12 dents  
082229

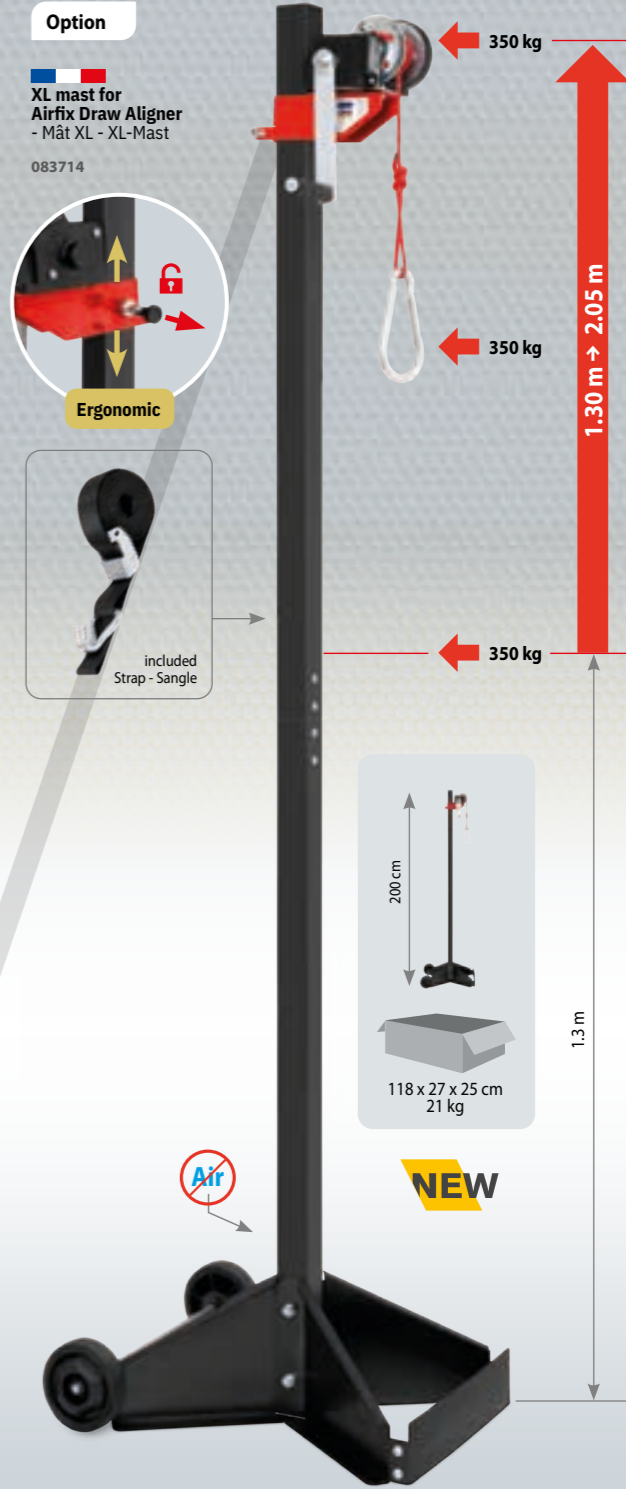
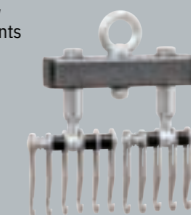

### Option

XL mast for  
Airfix Draw Aligner  
- Mât XL - XL-Mast  
083714



Ergonomic



included  
Strap - Sangle

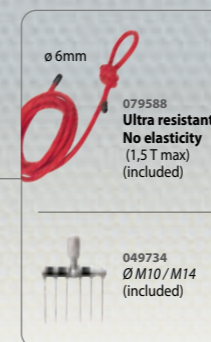

079588  
Ultra resistant  
No elasticity  
(1,5 T max)  
(included)

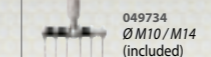

049734  
Ø M10 / M14  
(included)

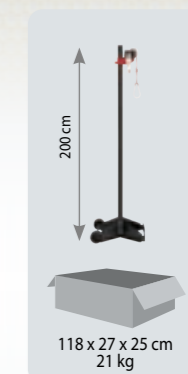

**NEW**



# PULLING SYSTEMS

**DRAW ALIGNER**

Draw aligner - Équerre de tirage - Schnellausbeul-Richtausleger  
052475

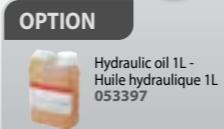
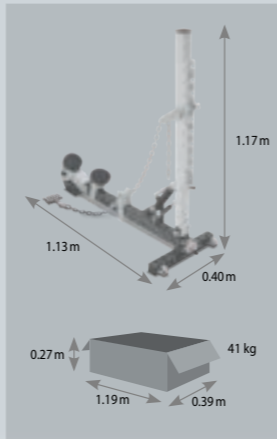
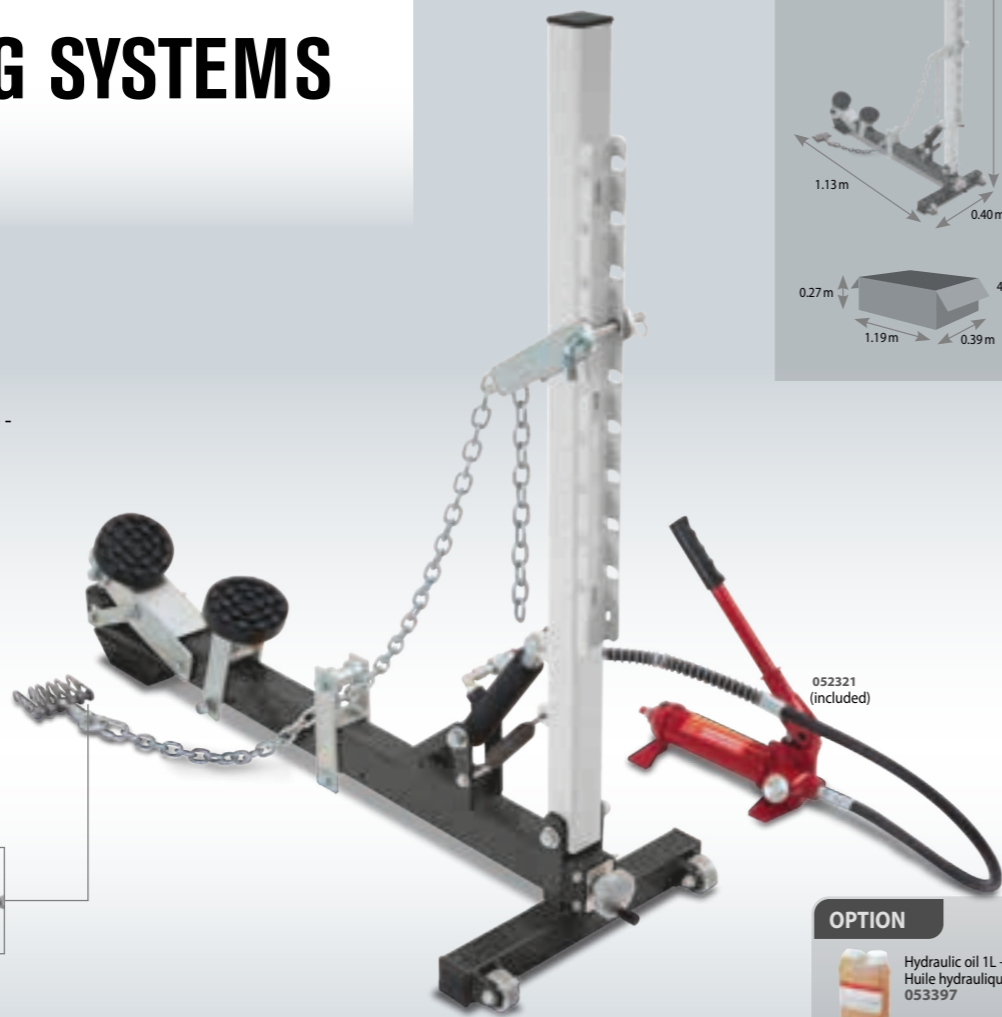
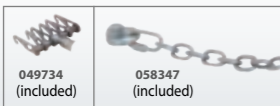
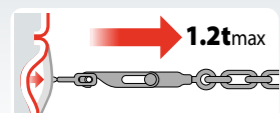
**INCLUDED**

Wedge for rocker panel - Cône pour bas de caisse

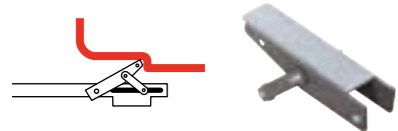

Pads kit for rocker panel - Kit patins pour bas de caisse

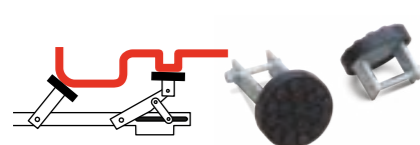
**OPTION**

Rocker panel arms for draw aligner - Bras de bas de caisse - Abstütztraverse für Richtausleger

052581

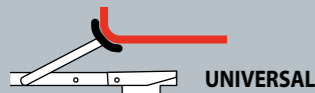
**UNIVERSAL**

7 kg

**OPTION**

12 tooth claw for pulling chain  
082229

**DRAW ALIGNER PRO**

069244

**INCLUDED**

Plate under the wheel - Cône sous roue  
Compatible with Draw Aligner & Draw Aligner Pro 076693



Wedge for rocker panel - Cône pour bas de caisse

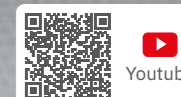
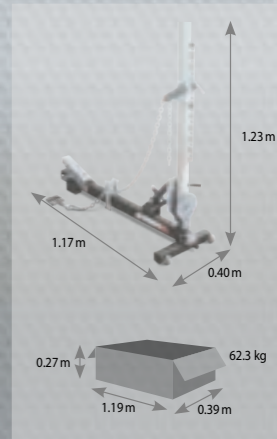
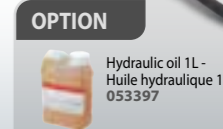
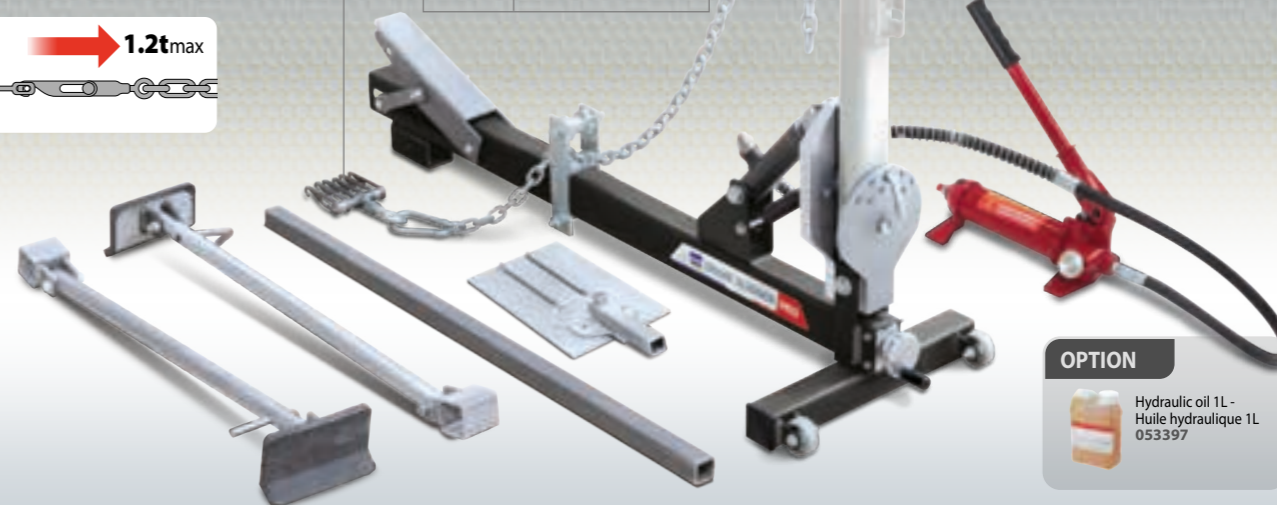
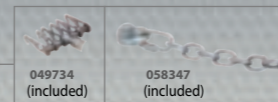
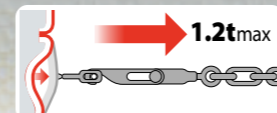

Rocker panel arms and stabilisation bar - Kit bras de bas de caisse et barre de stabilisation

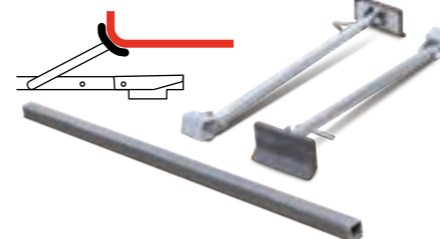
**OPTIONS**

Pads kit for rocker panel - Kit patins pour bas de caisse  
071278

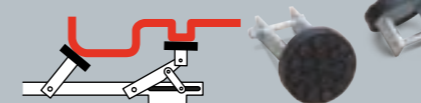

**ELECTRO POWER - Zug-Druckpresse**

with accessories : 057425



**INCLUDED**

Accessories kit : 425x620x150 mm  
Accessories kit  
Total weight: 20 kg



057418



Standard kit : 425x620x210 mm  
Standard kit  
Total weight: 18 kg

057401

Li-Ion battery 058514

**OPTION**

Pince écarteur 079496

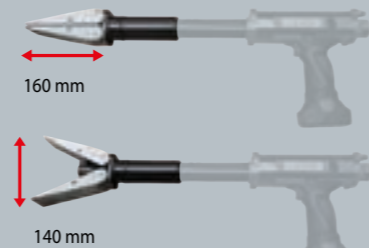

-PULLING POWER: 5 Ton.  
-PUSHING POWER: 5 Ton.  
-PISTON  
-STROKE: 130 mm

Spreading / Estensione

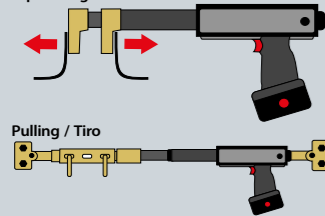

Pressing / Compressione

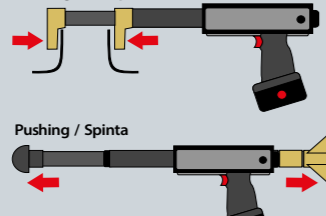

Pulling / Tiro

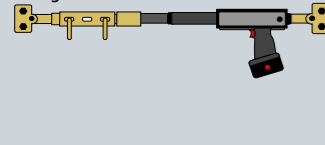

Pushing / Spinta

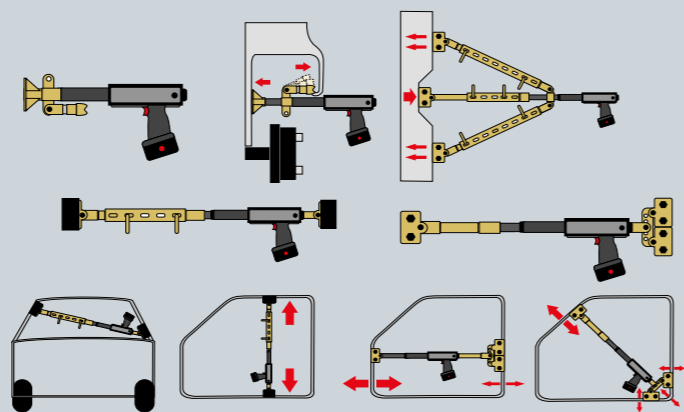
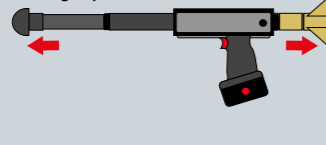

**ANCHOR BAR - Barre d'ancrage - Türspanner**

MADE IN TAIWAN

053045



053052



**INERTIA HAMMER KITS - Kits marteau à inertie - Ausziehhammer kit**

Inertia hammer kit  
- Kit marteau à inertie  
- Ausziehhammer kit  
051928

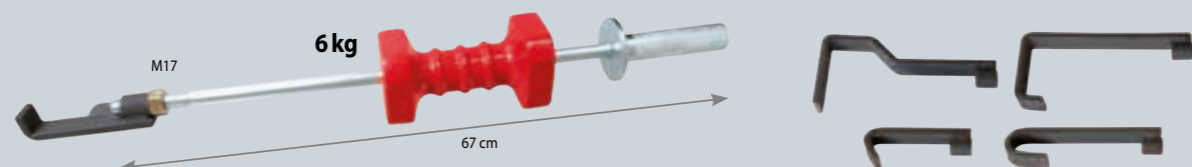

**NEW**  
5 kg  
+ 6 hooks  
087828



**NEW**  
9 kg  
+ 6 hooks  
085930

**HYDRAULIC CYLINDER KIT - Coffret vérin hydraulique - Hydraulischer Drucksatz**

MADE IN CHINA

**OPTION**



Hydraulic oil 1L - Huile hydraulique 1L 053397

**BASIC 4T**  
052345

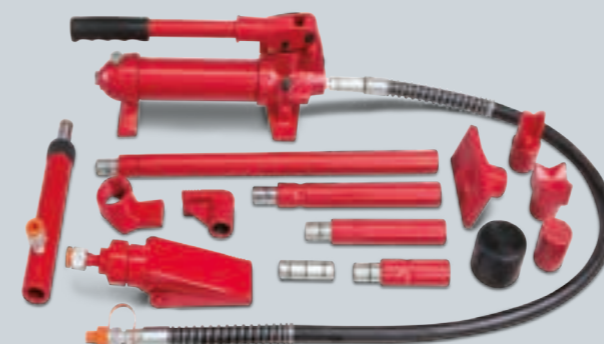

**BASIC 10T**  
052338



**PRO 4T**  
057432

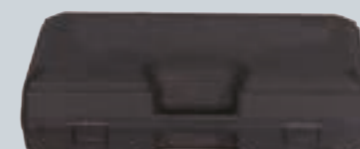

**PRO 10T**  
057449



**POWER-PULLER 4T**

059740



**MEASURING TOOLS - Mesures - Vermessung**

**BODYMETER, Mechanical measurements**

052130

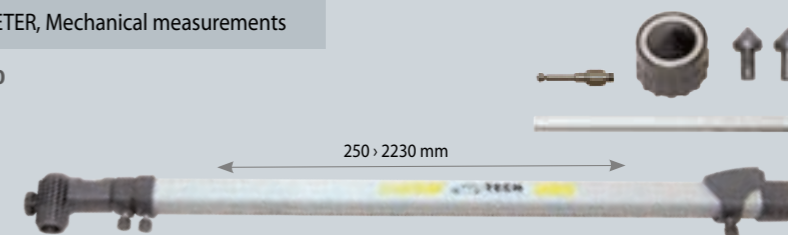

**GYSMETER, Electronic measurements**

052093

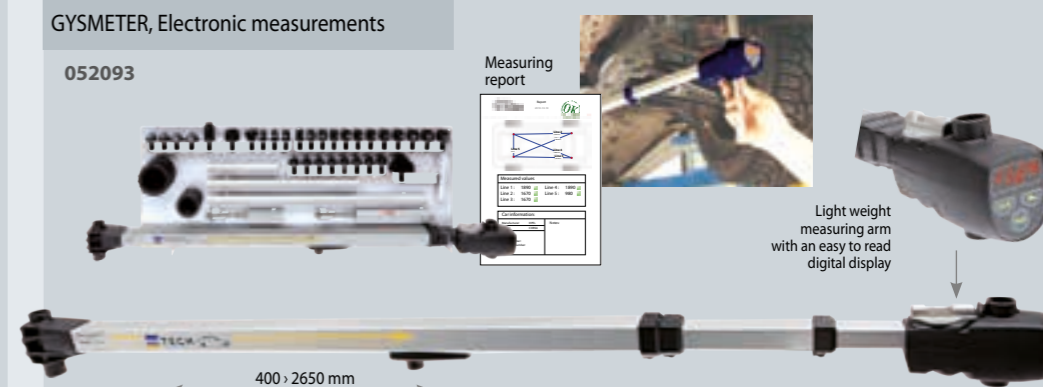

**PULL CLAMPS - Pinces de tirage - Ziehwerkzeuge**

Manual-locking pull clamp - Mini pince de tirage à blocage manuel - Mini Klemme von Auflage in Handblockieren 056855



5t

Self-locking pull clamp - Pince de tirage à blocage automatique - Selbstklemmende Zugklemme 052642



6t

Self-locking pull clamp - Pince de tirage à blocage automatique - Selbstklemmende Zugklemme 060944



6t

Right angle pull clamp - Pince de tirage à angle droit - Zugklemme 90° Winkel 052666



6t

**SWIVEL CLAMP - Pince pivotante**

060968



6t

240 mm

100 mm

**PULL HOOK - Crochet de tirage - Ziehwerkzeuge**

Boomerang pulling hook set - Kit crochet de tirage « boomerang » - Zughaken Set «Boomerang» 052659

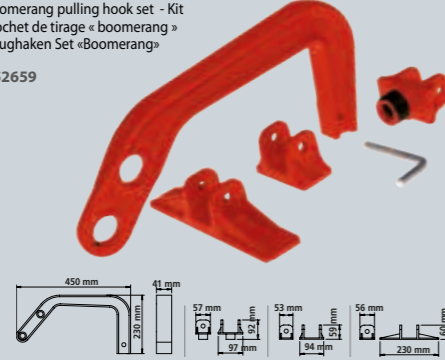

450 mm, 41 mm, 57 mm, 230 mm, 97 mm, 53 mm, 159 mm, 56 mm, 230 mm, 104 mm

**ARCH HOOKS - Passage de roue**

Large arch hook - Crochet passage de roue grande dimension 060982

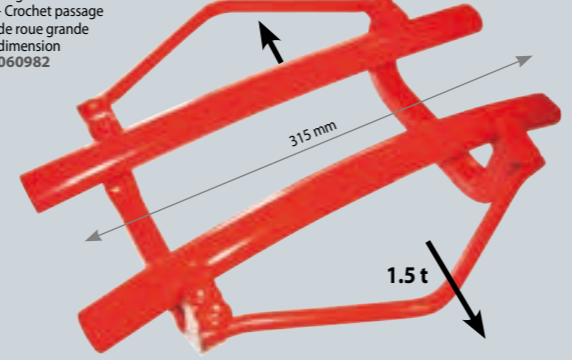

315 mm

1.5 t

**PULLING CHAIN - Chaînes de tirage - Ziehwerkzeuge**

Chain joint double grab hook - Raccord de chaîne double crochet 061156

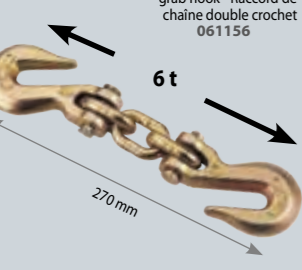

6t

270 mm

Chain joint for two clamps - Raccord de chaîne pour deux pinces 061163

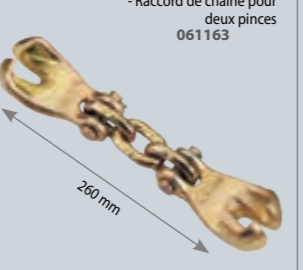

260 mm

Body chain 10 mm - Chaîne de tirage 10 mm 061255

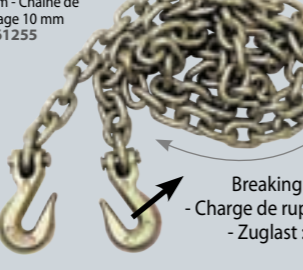

2.5 m

Breaking load - Charge de rupture - Zuglast: 12 t

12 tooth claw for pulling chain 082229

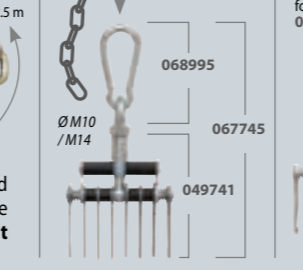

068995, 067745, 049741

**WIDE PULL CLAMPS - Pinces de tirage larges**

2-way - 2 directions 061217

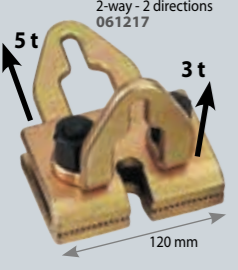

5t, 3t

120 mm

Multi-way - Multidirections 061224



5t, 3t

120 mm

**SMALL PULL CLAMPS - Pinces de tirage faible largeur**

Long nose clamp - Pince bec de canard 060951

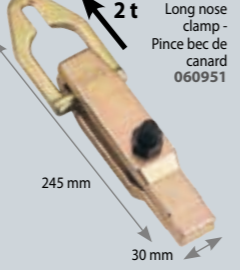

2t

245 mm, 30 mm

Small mouth pull clamp - Pince de tirage faible largeur 061231

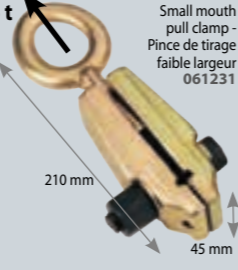

5t

210 mm, 45 mm

Box clamp - Pince contournement de rebord 061170

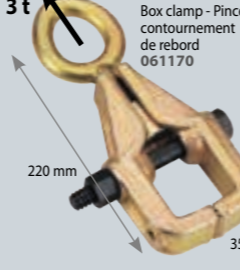

3t

220 mm, 35 mm

**MULTIPLE PULL CLAMP - Pince de tirage multiple**

Load spread multi clamp - Pince multiple répartition de charge 060999

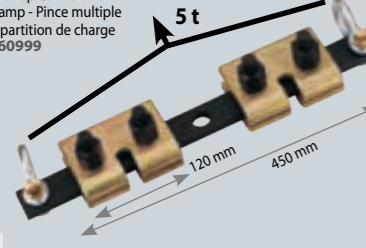

5t

120 mm, 450 mm

**45 MM SCISSORS CLAMP - Pince ciseaux largeur 45 mm**

061187

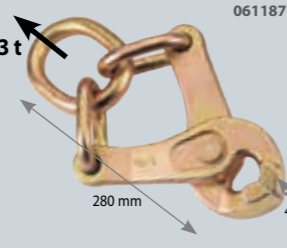

3t

280 mm, 45 mm

**90 DEGREE CORNER CLAMP - Pince de tirage pour angle 90°**

059757

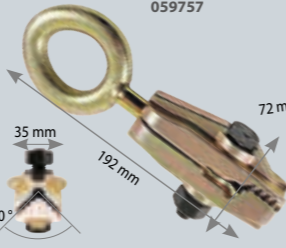

72 mm, 192 mm, 35 mm, 90°

**C TYPE CLAMP - Pince de tirage type C**

061200



5t

180 mm, 70 mm

**SMART SATELLITE - Satellite intelligent- Satellite Komplett-Kit**

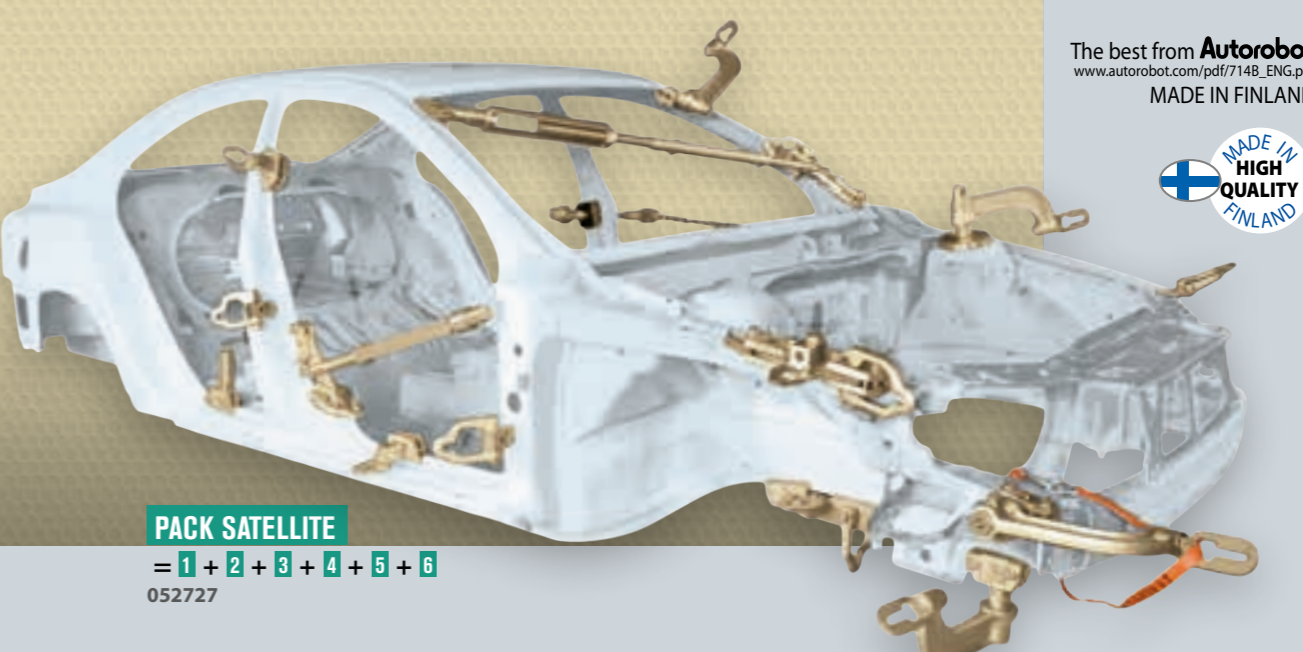

The best from **Autorobot**  
www.autorobot.com/pdf/7148\_ENG.pdf  
MADE IN FINLAND

**MADE IN HIGH QUALITY FINLAND**

**PACK SATELLITE**  
= 1 + 2 + 3 + 4 + 5 + 6  
052727

**1 SATELLITE - Satellite - Satellite Basisbügel-Set**

052710

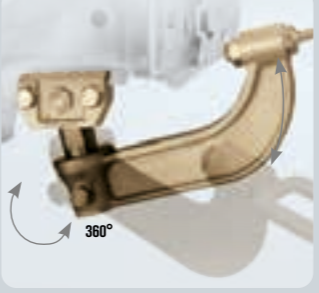
**2 KIT MAC PHERSON (A) - Mac Pherson Kit - Befestigungskit-Federbein (McPherson)**

052703



**3 BARRE POUR TIRER/POUSSER - Push/Pull Bar - Zug/Druck-Stangenset**

052673



**4 SATELLITE (B) - Bügelverlängerung**

052680



**5 SANGLE DE SÉCURITÉ - Safety Strap - Sicherungsgurt**

044036



**6 DOUBLE PINCE SATELLITE (C) - Double Clamp Satellite - Satellite Doppelklemme**

052697



**PINCE DE TIRAGE MULTI-USAGE - Versatile pulling clamp - Multifunktions-Zugklemme**

053571 **Autorobot**



**WELDING SHEETS KIT WITH CLAMP - Kit plaques à souder et pince**

083493 **NEW**



75 mm

25 mm (x1 included) 083509 x5  
38 mm (x1 included) 083516 x5  
50 mm (x1 included) 083523 x5  
75 mm (x1 included) 083530 x5



PDR: Paintless Dent Repair  
- Débosselage rapide et sans peinture  
- Lackschadenfreies Ausbeulen

# PAINTLESS DENT REPAIR

GYSDUCTION AUTO + Dent pulling inductor 054776 = GYSDUCTION AUTO DENT REPAIR 054981



50 Hz	A	W	Freq. kHz	INTEGRATED TECHNOLOGY	Liquid Cooling	Cable (m)	Inductor	LxWxH cm / kg	LxWxH cm / kg
230V, 1~	16	2400	35+120	PFC FV	—	2	2.5	52 x 30 x 37 / 9.4	37 x 21 x 37 / 7.5



## PAINTLESS DENT REPAIR LAMP

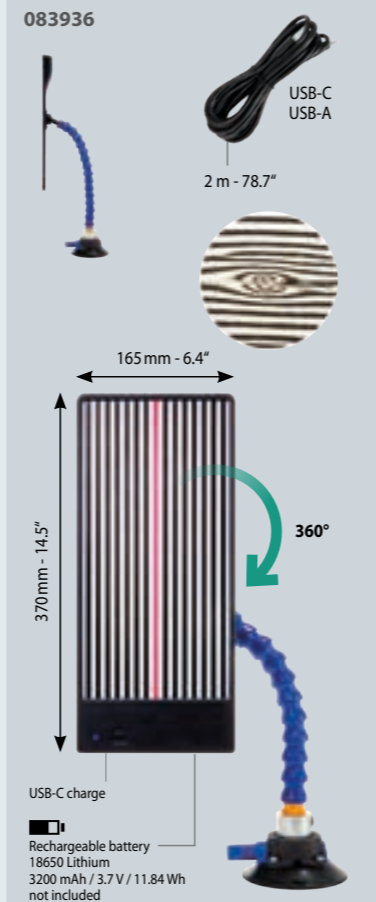

## DENT REMOVAL FLEXIBLE PANEL

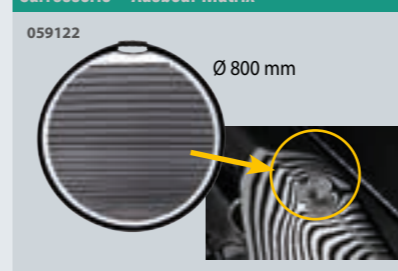

## GLUE PULLER PRO (Acier/Alu • Steel/Alu)

Glue Puller PRO 058699

Glue Puller PRO EXPORT 230V 059160

Glue Lifter 057364

250 W 110-240 V 052901

200 ml 050983

MADE IN FRANCE

Colle Glue

061392

x6 050952 Ø 16 Ø 21 Ø 32

x10 050976

200 ml 050983

## DENT PULLING KIT (PAINTLESS)

- Kit débosselage sans peinture - Dellenausbeulhebel-Set



## SET OF 6 PENCIL PUNCHES

- Kit de 6 coins de frappe - Beulenstemmer-Satz mit 6 Tefloneinsätzen



## PNEUMATIC INERTIA HAMMER

- Marteau inertie pneumatique - Unterdruck-Schlaghammer

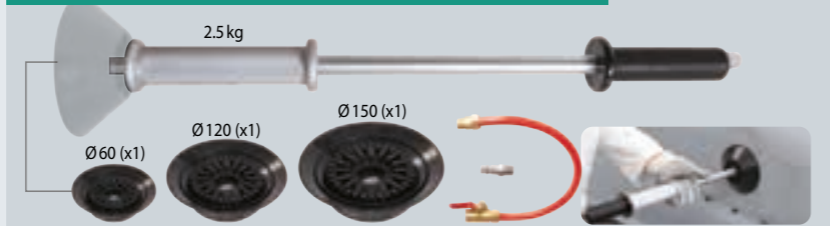

## PUMP AIR SUCTION SLIDE HAMMER

- Marteau à inertie à ventouses (pompage manuel) - Man. Unterdruck-Schlaghammer



## BARRETTES ANNEAUX PLASTIQUE - Plastic Multipads Ösen-Klebe pads



## OPTIONS

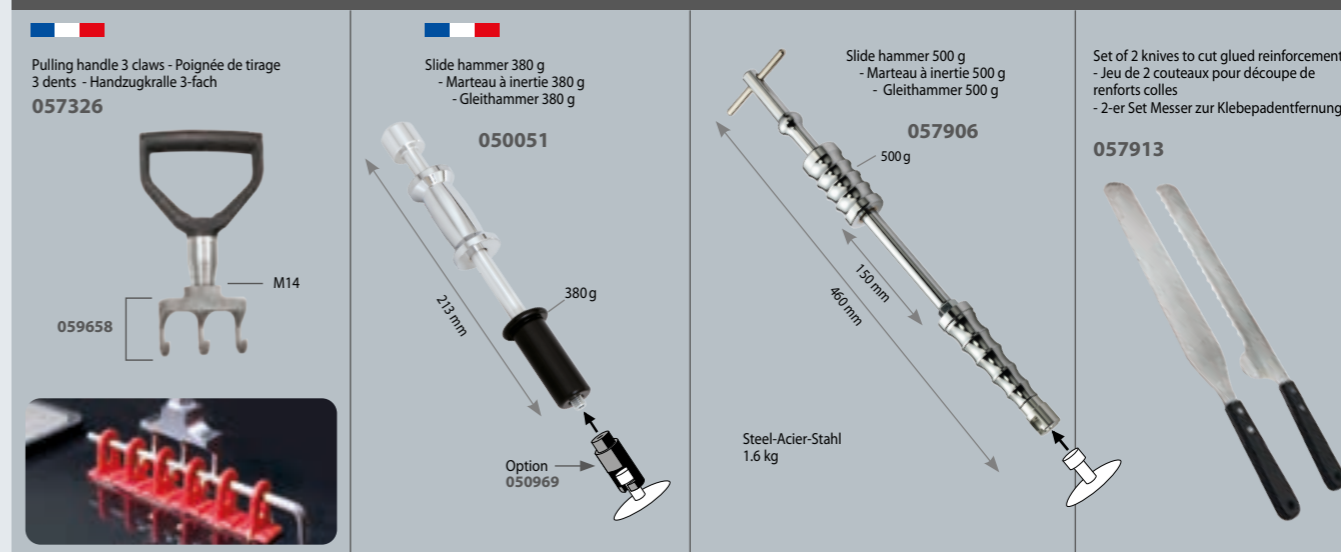





GPR: Glue Pulling Repair  
- Débosselage par colle  
- Lackschadenfreies Ausbeulen

# GLUE PULLING REPAIR



## GPR I-BAR MINI



080324



## GPR FLEXIBLE TABS

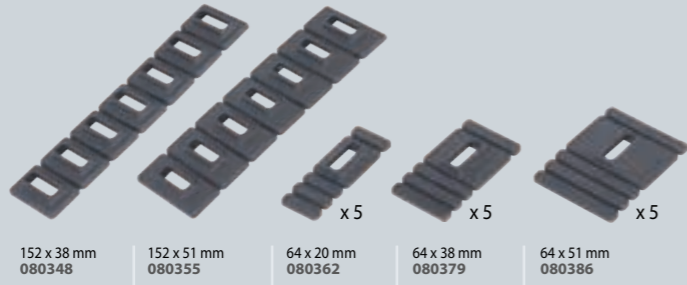

## GPR FLAT TABS

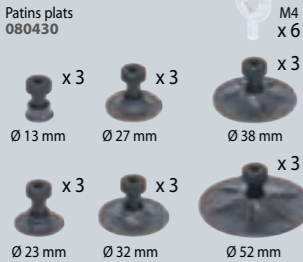

## GPR 3D TABS

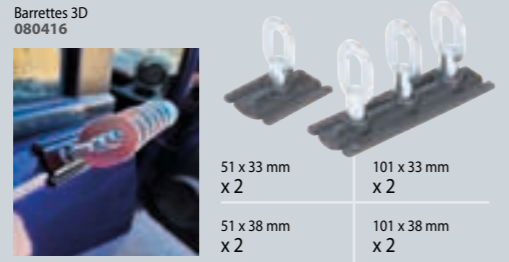

## GPR 3D CURVE TABS

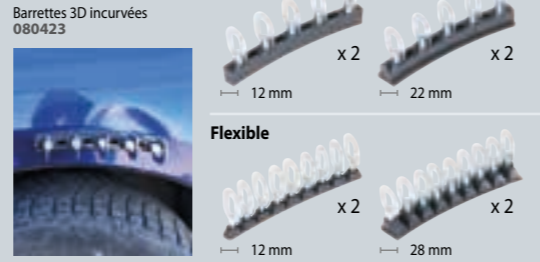

## GPR UNIVERSAL TABS

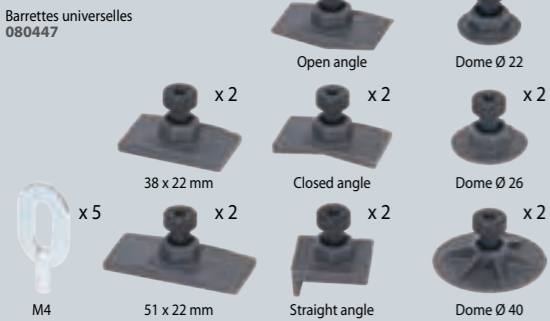

## GPR FOLD TABS

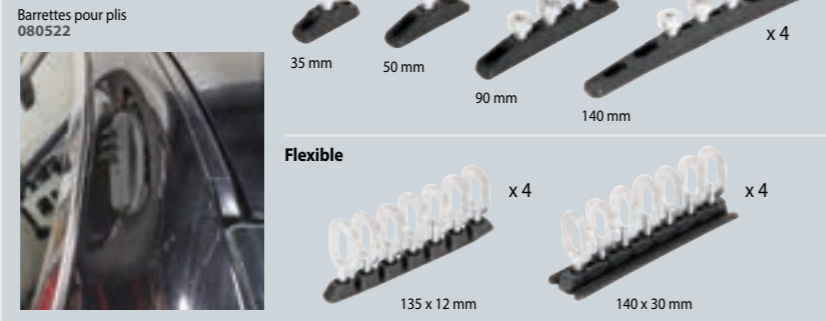

## GPR HAIL IMPACT TABS



## GPR BAR TABS

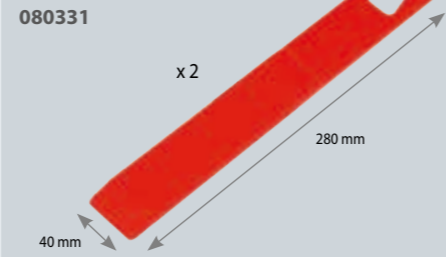

## GLUE GUN 400W - Pistolet à colle chaude 400W

082144



GPR PRO Glue sticks  
- Bâtons de colle  
080454



GPR PRO Glue sticks for stripped sheets  
- Bâtons de colle pour tôles découpées  
081017

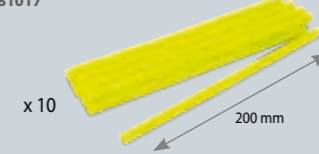

Workstation Premium -  
Servante Premium  
076143



(p. 144)

## GPR PRO KIT

080317



1	GPR I-bar mini	51 mm	x 1
<b>GPR Flexible tabs</b>			
2	64 x 20 mm		x 1
	64 x 38 mm		x 1
	64 x 51 mm		x 1
<b>GPR Long tabs</b>			
3	152 x 38 mm		x 1
	152 x 51 mm		x 1
<b>GPR Plastic hooks</b>			
4			x 10
<b>GPR Bar tab</b>			
5			x 1
<b>GPR 3D tabs</b>			
6	12 mm		x 1
	22 mm		x 1
<b>GPR 3D curved tabs</b>			
7	51 x 38 mm		x 1
	101 x 38 mm		x 1
<b>GPR M4 steel hooks</b>			
8			x 5
<b>GPR Universal tabs</b>			
Flat 38 x 22 mm			x 1
Flat 51 x 22 mm			x 1
Open angle 38 x 22 mm			x 1
Closed angle 38 x 22 mm			x 1
Straight angle 27 x 22 mm			x 1
Dome Ø 22 mm			x 1
Dome Ø 26 mm			x 1
Dome Ø 40 mm			x 1
<b>GPR Flat tabs</b>			
Ø 13 mm			x 1
Ø 23 mm			x 1
Ø 27 mm			x 1
Ø 32 mm			x 1
Ø 38 mm			x 1
Ø 52 mm			x 1
<b>GPR Bars for folds</b>			
35 mm			x 1
50 mm			x 1
90 mm			x 1
140 mm			x 1
Flexible 135 mm			x 1
140 x 30 mm			x 1
<b>GPR Glue sticks</b>			
12			x 10

Isopropyl alcohol  
99.9% + spray - Alcool  
isopropyloque 99,9% +  
vaporisateur  
082236



1 L 600 ml

Heat gun - Décapeur  
thermique  
066311



Digital display -  
Affichage numérique  
I: 100/300°C (450 W)  
II: 300/650°C (1500 W)  
Air flow: 450 l/min

Gas hot air gun  
- Pistolet à air chaud  
autonome à gaz  
060777



Gas included -  
Bouteille incluse

Blow torch - Lampe à  
souder  
052741



Gas not included -  
Bouteille non incluse

Novacet +  
Butane/Propane/Propylène  
040441



380 ml (220 g)

Infrared  
thermometer  
- Thermomètre infrarouge  
079922



Adjustable emissivity:  
0.10-1.00

Set of 6 pencil  
punches - Kit de 6  
coins de frappe  
052888



(p. 46)

3 plastic wedges  
- 3 cales plastiques  
051294



Lifting rod 180 mm  
- Tige de tirage 180 mm  
082915



Pulling hand 3  
claws - Poignée de  
tirage 3 dents  
057326



(p. 47)

Slide hammer 500g  
- Marteau à inertie 500g  
057906

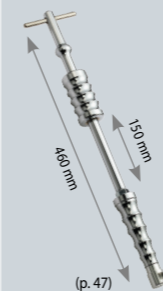

(p. 47)

Slide hammer 1.7kg  
- Marteau à inertie 1,7kg  
051201

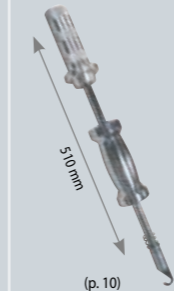

(p. 10)

Glue Lifter  
057364



included  
061392

(p. 47)

Arc Puller  
Premium  
065161



included  
Alu 3  
065161

(p. 19)

Arc Puller  
Premium Pro  
072572



included  
Alu 4  
065185

(p. 19)

Premium Pro  
Levelling bar  
900 mm  
071643

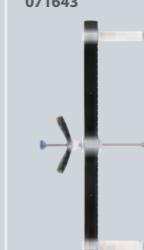

(p. 23)

Airfix Draw Aligner  
077379



(p. 39)

**GYS GLUE PULLING REPAIR KITS**



085770

**NEW**

111 pcs



**6 rectangular red end tabs**  
- 6 embouts rectangulaires rouges  
085312



**10 flat pink end tabs**  
- 10 embouts plats roses  
085329



**4 green domed end tabs**  
- 4 embouts verts bombés  
085398



**12 black multiform tabs**  
- 12 embouts multiformes noirs  
085978



**2 blue bars with 4 plastic rings**  
- 2 barres bleues avec 4 anneaux plastiques  
085251

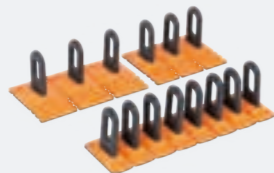

**3 tabs with 14 plastic rings kit**  
- Kit 3 languettes avec 14 anneaux plastiques  
085282

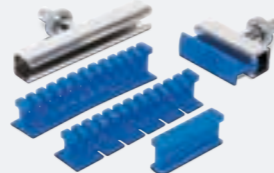

**4 blue pull bars with metal rail**  
- 4 barettes de tirage bleues avec rail métal  
085299



**10 blue multiform pulling bars**  
- 10 barettes de tirage multiformes  
085305



**Tapping hammer**  
- Marteau à frapper  
085411



**Dent removal aluminium pen**  
- Outils de débousselage stylo en aluminium  
085404



**Dent removal clamp**  
- Pince de débousselage  
085435



**400 W hot glue gun**  
- Pistolet à colle chaude 400 W



**Rubber mallet**  
- Marteau caoutchouc  
085428



**Pulling handle**  
- Poignée de tirage  
085442



**Plastic wedge**  
- Cale plastique



**Spray bottle 600 ml**  
- Vaporisateur 600 ml



**Inertia hammer 200 g**  
- Marteau à inertie 200 g  
085459



**10 glue sticks** - 10 bâtons de colle  
085183

**EUROPE NEW**

085466



+ Isopropyl alcohol 99.9% - Alcool isopropyloque 99,9% 1L

**EUROPE NEW**

087842



+ Isopropyl alcohol 99.9% - Alcool isopropyloque 99,9% 1L

**GYSMART GPR WORKSTATIONS**

087859

**NEW**



**GYS GPR KIT**  
085770

111 pcs



**Workstation Premium - Servante Premium**  
076143



**Heat gun**  
- Décapeur thermique  
066311



**30 glue sticks** - 30 bâtons de colle  
087835



**Dent repair lamp**  
- Lampe de débousselage  
083936



**Infrared thermometer**  
- Thermomètre infrarouge  
079922



**Slide hammer 1.7kg**  
- Marteau à inertie 1,7kg  
051201



**Alu hammers** - Marteaux alu  
020986



**Arc Puller Premium Pro**  
072572

Alu 3  
065161

Alu 4  
065185

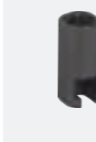

**Steel**  
079830



**4 tooth claw**  
- Griffes 4 dents  
049758



**Leveling bar** - Barre de débousselage  
050693

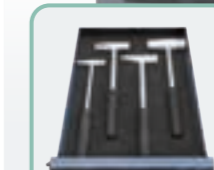

**Isopropyl alcohol 99.9% + spray** - Alcool isopropyloque 99,9% + vaporisateur 082236



1 L 600 ml

**Glue sticks** - Bâtons de colle



x 10 085183 x 30 087835

**Gas hot air gun** - Pistolet à air chaud autonome à gaz 060777



Gas included - Bouteille incluse

**Blow torch** - Lampe à souder 052741



Gas not included - Bouteille non incluse

**Novacet +** Butane/Propane/Propylène 040441



380 ml (220 g)

**Set of 6 pencil punches** - Kit de 6 coins de frappe 052888



(p. 46)

**3 plastic wedges** - 3 cales plastiques 051294



**Lifting rod 180 mm** - Tige de tirage 180 mm 082915



**Pulling hand 3 claws** - Poignée de tirage 3 dents 057326



(p. 47)

**Slide hammer 500g** - Marteau à inertie 500g 057906

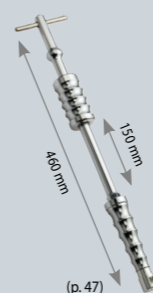

(p. 47)

**Glue Lifter** 057364



included 061392

(p. 47)

**Arc Puller Premium** 065161

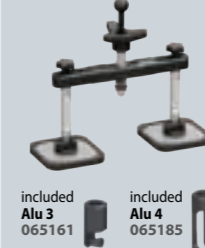

included Alu 3 065161

included Alu 4 065185

(p. 19)

**Premium Pro Levelling bar 900 mm** 071643



(p. 23)

**Airfix Draw Aligner** 077379



(p. 39)



# RESISTANCE SPOT WELDING

RANGES 54

## PRESENT MACHINES

PORTASPOT / BP.LX / PTI-S7 56

BP GENIUS 58

PTI GENIUS 60

## NEW MACHINES WITH COLOUR SCREEN

PTI NEO 62

PTI MASTER / PTI EXPERT 64

## ARMS & CONSUMABLES

G ARMS 66

ACCESSORIES & CONSUMABLES 67

X ARMS / C ARMS 68

# CAR MANUFACTURER REQUIREMENTS

EXIGENCES CONSTRUCTEUR - ANFORDERUNGEN DES AUTOMOBILHERSTELLERS  
- REQUISITI DEL PRODUTTORE DI AUTOMOBILI

An example of new generation car body  
• Exemple de carrosserie nouvelle génération  
• Beispiel einer Karosserie der neuen Generation  
• Esempio di carrozzeria di nuova generazione

- HSS - HLE
- Bore - Boron
- VHSS - THLE
- Aluminium
- UHSS - UHLE

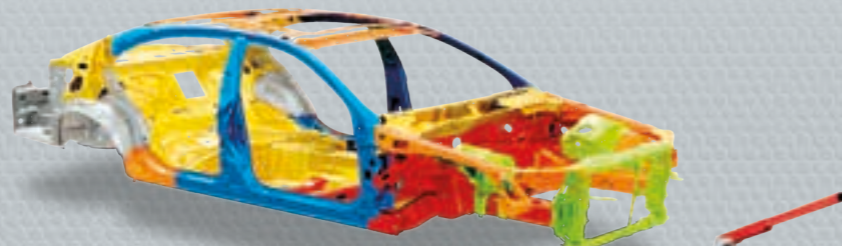

MIG/MAG PLUG WELDING - Bouchonnage MIG/MAG

VS

RESISTANCE SPOT WELDING - Soudure par résistance

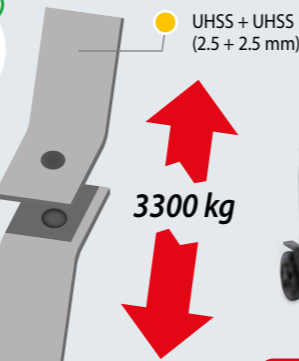
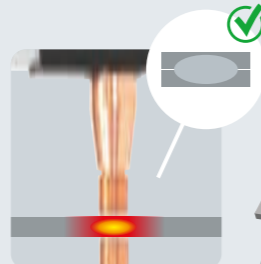
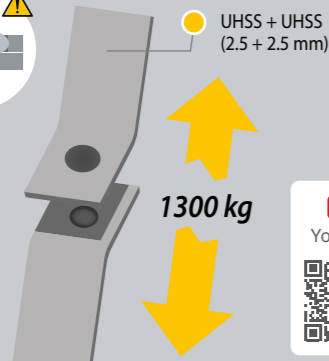
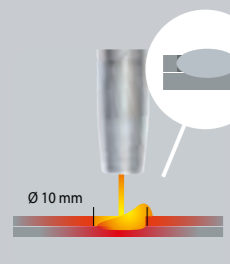

Non-compliant with car manufacturer requirements  
- Non conforme aux exigences constructeur

Same mechanical resistance as original  
- Même résistance mécanique qu'un point d'origine

INVERTER machine

# MANUFACTURER APPROVALS / COMPLIANCE

HOMOLOGATIONS PRODUITS - PRODUKT HOMOLOGATIONEN - PRODOTTI APPROVATI



	Volkswagen Group	Rivian	BMW / Mini / Rolls Royce	Jeep	Mercedes	smart	Evobus	Mercedes	Jaguar / Land Rover	Ford USA	Honda USA	NISSAN	LYN&CO	BYD
<b>DEBIT PULLER</b>														
GYSPOT 26.02/27.02														
GYSPOT 34.02/04, 36.02/04, 39.02/04, PRO230/400, EXPERT 200/230/400														
Workstations														
GYSPOT ALU FV														
GYSPOT ARCPULL 200														
GYSPOT BP-LX														
<b>RESISTANCE SPOT WELDER</b>														
GYSPOT BP GENIUS														
GYSPOT PTI-s7														
GYSPOT PTI GENIUS														
GYSPOT PTI NEO, MASTER														
GYSPOT PTI EXPERT														
VAS 821 101 - Spot Welder														
VAS 821 101A - Spot Welder														
BMW C7502654														
<b>RIVE TIME</b>														
GYSPRESS														
E1 GYS AUTO														
E2, E3 GYS AUTO														
P1, P2, P3 GYS AUTO														
<b>MIG / MAG</b>														
AUTOPULSE 220-M1														
AUTOPULSE 220-M2														
AUTOPULSE 220-M3														
AUTOPULSE 320-T1														
AUTOPULSE 320-T3														
VAS 821 005 - Pulse MIG														
VAS 821 00580 023														
<b>PLASMA</b>														
EASYCUT 40														
CUTTER K25, K35														
EASYCUT 30FV, CUTTER 45CT														
GYSDUCTION AUTO														

Homologated by car manufacturers

Meets the specifications of car manufacturers



Monochrome Screen Generation



	PTI s-7	BP GENIUS	PTI GENIUS
<b>Machine type</b> - Type de machine	Transformer in the clamp	Cable	Transformer in the clamp
<b>Arm</b> - Bras	C	G	G
<b>Max welding current</b> - Courant de soudage max	14500 A	13000 A	14500 A
<b>Max tightening force</b> - Effort de serrage max	550 daN	550 daN	550 daN
<b>Clamp weight</b> - Poids de la pince	9.9 kg	6.5 kg	11.3 kg
<b>Electrode with over-opening</b> - Electrode avec sur-ouverture	—	Pneumatic	Pneumatic
<b>Welding max frequency</b> - Cadence max de soudage	10 pts/min	20 pts/min	20 pts/min
<b>Automatique mode</b> - Mode automatique	•	•	•
<b>Cooling system</b> - Système de refroidissement	30 litres	30 litres	30 litres
<b>Duty cycle</b> - Facteur de marche	★★★★	★★★★	★★★★★
<b>Clamp cable length</b> - Longueur faisceau pince	4 m or 6 m	2.5 m	6 m
<b>Gyro</b> - Gyro	(Option)	• Ball bearing Gyro	• Ball bearing Gyro
<b>Mains cable length</b> - Longueur câble secteur	8 m	8 m	8 m
<b>Balancing arm</b> - Avec potence	•	•	• Electric, adjustable height
<b>Disconnectable clamp</b> - Pince déconnectable	•	—	—
<b>Single sided gun</b> - Pistolet monopoint	(Option)	•	(Option)
<b>Software update &amp; Traceability</b> - Mise à jour logicielle et traçabilité	SD card	SD card	SD card

3.5" Colour Screen Generation



	PTI NEO	PTI MASTER	PTI EXPERT
<b>Machine type</b> - Type de machine	Transformer in the clamp	Transformer in the clamp	Transformer in the clamp
<b>Arm</b> - Bras	G	G	G
<b>Max welding current</b> - Courant de soudage max	13000 A	13000 A	14500 A
<b>Max tightening force</b> - Effort de serrage max	550 daN	550 daN	550 daN
<b>Clamp weight</b> - Poids de la pince	9.7 kg	10.3 kg	11.8 kg
<b>Electrode with over-opening</b> - Electrode avec sur-ouverture	—	Mechanical	Mechanical
<b>Welding max frequency</b> - Cadence max de soudage	10 pts/min	10 pts/min	10 pts/min
<b>Automatique mode</b> - Mode automatique	•	•	•
<b>Cooling system</b> - Système de refroidissement	5 litres	5 litres	30 litres
<b>Duty cycle</b> - Facteur de marche	★★★	★★★	★★★★★
<b>Clamp cable length</b> - Longueur faisceau pince	4 m	4 m	5 m
<b>Gyro</b> - Gyro	—	—	•
<b>Mains cable length</b> - Longueur câble secteur	8 m	8 m	8 m
<b>Balancing arm</b> - Avec potence	—	—	•
<b>Disconnectable clamp</b> - Pince déconnectable	—	—	•
<b>Single sided gun</b> - Pistolet monopoint	(Option)	(Option)	(Option)
<b>Software update &amp; Traceability</b> - Mise à jour logicielle et traçabilité	USB	USB	USB



# RESISTANCE SPOT WELDING

PORTASPOT 230

## 6 300 A 120daN

Air cooled

230V  
022256

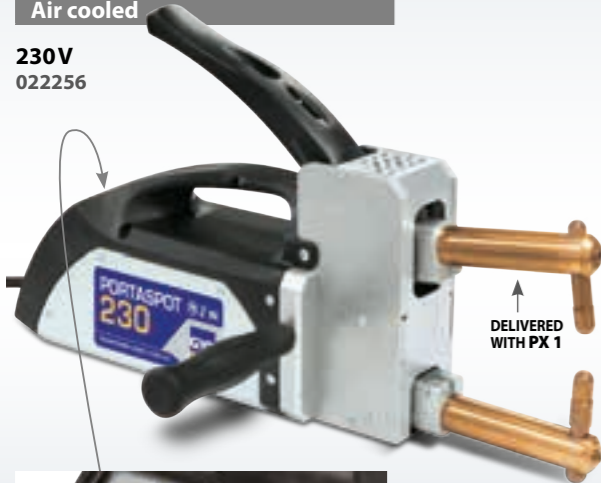

DELIVERED WITH PX 1



ARMS Ø 23 mm

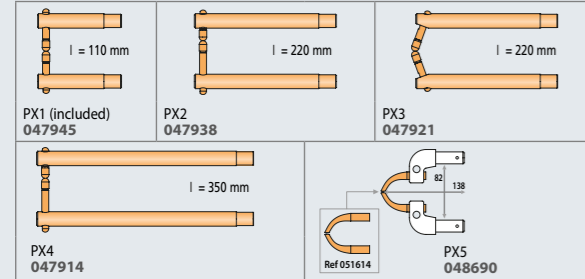

ELECTRODES

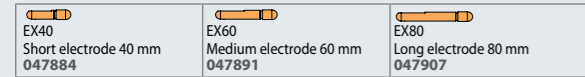

CAPS & ACCESSORIES

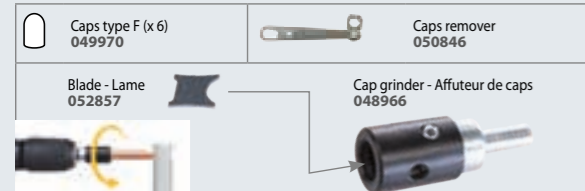

50/60 Hz	AM	RMS	MAX	Uo	Cable	100% CU	LxWxH cm / kg
1 x 230V	16(D)	6 300	8 900	2+2	2.45	2.5	3x2.5 H05VVf 0K 41 x 18 x 22 / 11.3

**GVSPOT BP-LX**  
**13 000 A**  
550 daN

For mild steel, HSS, UHSS Boron steel

Double pressure  
Ø 10 mm  
6.5 kg (included X1)

Liquid cooled

**BP BODYPROTECT**  
Unique electro-magnetic field protection  
2013/35/EU by GYS

Traceability software  
Save spot welding configuration and export data

X ARMS

	019652	058804
Gyspot BP-LX		
Monopoint/Spot 049291	■	■
Spotter box pro (p.10) 050075	■	■
Inertia hammer 049482 + 049802	■	■
X1 050501	■	■
X4A (x2) + X4B + X4C + X2 020733	■	■
Liquid cooling (10L) 052246		■ (x3)

OPTIONS

050068  
x10 (x20: 052239) x18 (x6: 049987)  
x6 (x6: 049994) x18 (x6: 049970)

Caps type A box 048935 x40 (x6: 049987)  
Caps type F box 077119 x40 (x6: 049970)

2L 082212  
5L 062511  
10L 052246

SD CARD 050914  
Mandrels for gun  
51 < nov 2010 048171  
52 > nov 2010 048188

Protection cover for BP & PTI 050853

GYRO 360° for PTI S-7 051720  
Kit gun for PTI S-7 067318

200 mm² 1.6 m  
300 mm² 1m  
10-14 kg 059696



**GVSPOT PTI-s7**  
**14 500 A**  
550 daN

For mild steel, HSS, UHSS Boron steel

FUSE 20 A  
Double pressure  
Ø 10 mm  
9.9 kg (included C1)

TRANSFORMER INSIDE

Liquid cooled

Traceability software  
Save spot welding configuration and export data

C ARMS

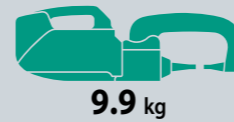

9.9 kg



TESLA APPROVED  
COLLISION TOOLS, EQUIPMENT & CONSUMABLES



	220V		400V	
	6M 022195	6M 020900	4M 020894	4M 067998
Gyspot PTI-s7	■	■	■	■
Contact grease 050440	■	■	■	■
Caps remover 050846	■	■	■	■
Arm panel	■	■	■	■
C1 021402	■	■	■	■
C2 + C3 + C4 060821	■	■	■	■
C6 022409	■	■	■	■
Gyro 360° 051720	■	■	■	■
Complete gun kit 067318	■	■	■	■
Liquid cooling (10L) 052246				■ (x3)

Convert PTI S-7 to Premium Pro  
220V 072367  
400V 072541

C ARMS G ARMS

MADE IN FRANCE 62135	50/60 Hz	RMS	A	Spots/min (max)	Uo	mm			Cables				cm	kg
						↕	↔	↔	↔	↔	↔	↔		
GVSPOT BP.LX	3 x 400V	13 000	32 (22 kVA) 40 (28 kVA) 50 (35 kVA)	2 6 10	16	2.5+2.5+2.5	1.5+3	2.5 m, liquid	—	2.5 m, air	8 m, 4x4 mm² H07RN1F	65 x 80 x 205	164.5	
GVSPOT PTI-s7	3 x 400V	14 500	20 (14 kVA)	10	7.3	2.5+2.5+2.5	1.5+3	4 m, liquid or 6 m, liquid	4 m, liquid or 6 m, liquid	OPTION 067318 : 1.6 m, Ø 200 mm²	8 m, 4x4 mm² H07RN1F	65 x 80 x 230	105.3	
GVSPOT PTI-s7 220 V	3 x 200V 208 V 230V 240V	12 500 13 000 14 500 14 500	40 (14-16 kVA)	10	6.5 6.7 7.4 7.7	2.5+2.5+2.5	1.5+3	4 m, liquid or 6 m, liquid	4 m, liquid or 6 m, liquid	OPTION 067318 : 1.6 m, Ø 200 mm²	8 m, 4xAWG8 (SOOW)	65 x 80 x 230	115.7	



GYSPOT

# RESISTANCE SPOT WELDING BP GENIUS

**G**  
ARMS



MADE IN FRANCE

G-clamp front  
body + protection  
078765

**ULTRA LIGHT  
& COMPACT**  
6.5 kg  
(Gyro & G1 included)

550 daN



6.5 kg  
(Gyro & G1 included)



Youtube

## FAST OPEN XL

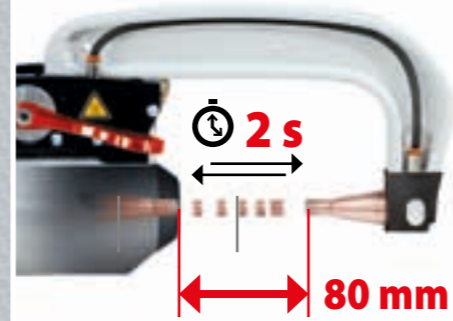

## EASY



## GYRO INTEGRATED



## PERFECT ELECTRICAL CONNECTION



## AUTO

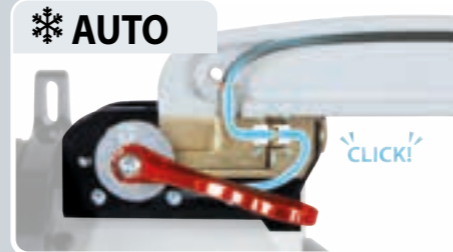

## GYSPOT BP GENIUS

**13 000 A**  
550 daN

For mild steel, HSS, UHSS **Boron steel**

**BP** BODYPROTECT  
Unique electro-magnetic field protection  
by GYS

Traceability software  
Save spot welding configuration  
and export data



	023451	082250
<b>400V</b>		
Monopoint/Spot 049291	▪	▪
Spotter box pro (p.10) 050075	▪	▪
Inertia hammer 049482 + 049802	▪	▪
Caps remover 050846	▪	▪
Arm support G1 022768	▪	▪
G2 + G3 + G4 022898	▪	▪
Liquid cooling (10L) 052246	▪	(x3)
Caps type A box 048935	▪	▪
Protection cover 050853	▪	▪



Included  
Protection  
067271

120 cm

210 cm  
80 cm

Included  
Cable support for BPLG  
ULTRA RESISTANT  
059719

Gun & cable support

### OPTIONS

	Caps type A box 048935 x40 (x6: 049987)		Caps type F box 077119 x40 (x6: 049970)		SD CARD 050914		Cooling liquid - Liquide de refroidissement - Kühlmittel - Enfriamiento líquido - Refrigeração líquida 2L 082212 5L 062511 10L 052246		Protection cover - Houise de protection - Schutzhaube for BP & PTI 050853		10-14 kg 059696
	073449		073449								

			RMS		A D curve	Spots max	U <sub>o</sub>		mm	Cables			100% CU		cm		kg
MADE IN FRANCE	62135	50/60 Hz	A	A	D curve	2 5 6 10	V	2.5+2.5+2.5	1.5+3	2.5 m, Ø 200 mm <sup>2</sup> , Liquid	2.5 m, Ø 150 mm <sup>2</sup> air	8 m 4x6 mm <sup>2</sup> H07RN-F	OK	65 x 80 x 205		171	
<b>GYSPOT BP GENIUS 400V</b>		3 x 400V	<b>13000</b>	<b>32</b> (22 kVA) <b>40</b> (28 kVA) <b>50</b> (35 kVA)		2 6 10	16	2.5+2.5+2.5	1.5+3								



59

GYSPOT BP GENIUS

LIQUID COOLED



GYSPOT

# RESISTANCE SPOT WELDING PTI GENIUS



MADE IN FRANCE

550 daN

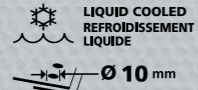

11.3 kg  
(Gyro & G1 included)

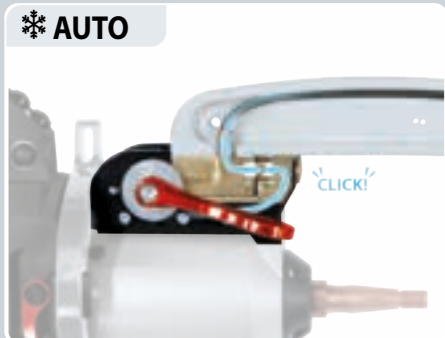
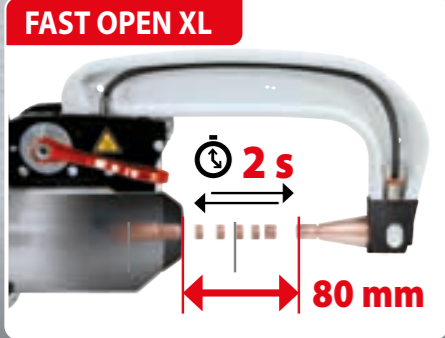

**TRANSFORMER INSIDE**



**G ARMS**

G-clamp front body + protection 078765

Control command - Contrôle de commande



Motorised cable support - Potence électrique - Elektrisch verstellbarer Kabelsupport

- OPTIONS**
- Caps type A box 048935
    - x20 (x6: 049987)
    - x40 (x6: 049987)
  - Caps type F box 077119
    - x40 (x6: 049970)

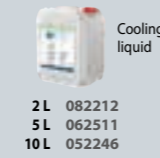
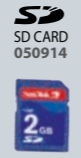
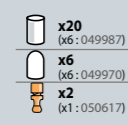

for PTI GENIUS 077126

## GYSPOT PTI GENIUS

**14 500 A**  
550 daN

For mild steel, HSS, UHSS **Boron steel**

**TRANSFORMER INSIDE**

Liquid cooled

Traceability software  
Save spot welding configuration and export data



	024878	082267	024854	024892
	400V		220V	480V
Gyspot PTI-GENIUS	■	■	■	■
Caps remover 050846	■	■	■	■
Arm support	■	■	■	■
G1 022768	■	■	■	■
G2 + G3 + G4 022898	■	■	■	■
Liquid cooling (10L) 052246		(x3)		
Caps type A box 048935	■	■	■	■
Protection cover 077126	■	■	■	■

**Ergonomic**

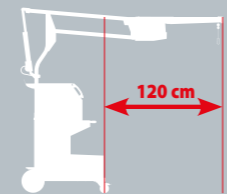

**ELECTRIC MOTOR**



Included Cable support ULTRA RESISTANT

Control Commande

Electrode storage - Rangement pour électrodes

6 m

High stability - Grande stabilité

**OPTIONS**

Kit gun 067226



MADE IN FRANCE 62135	RMS A	+AM- A D curve	Spots/min (max)	Uo		mm		Cables		cm	kg	
				V	mm	mm	mm	mm				
<b>GYSPOT PTI GENIUS 400V</b>	3 x 400 V	<b>14 500</b>	<b>25 (17 kVA)</b>	<b>20</b>	7	2.5+2.5+2.5	1,5 + 3	6 m, Liquid	8 m 4x4 mm <sup>2</sup> H07RN-F	71 x 90 x 200	127.7	
<b>GYSPOT PTI GENIUS 220 V</b>	3 x	200	<b>12 500</b>	<b>50 (17-21 kVA)</b>	<b>20</b>	6.6	2.5+2.5+2.5	1,5 + 3	6 m, Liquid	8 m 4xAWG8 (500W)	71 x 90 x 200	136.2
		208	<b>13 000</b>			6.9						
		230	<b>14 500</b>			7.3						
		240	<b>14 500</b>			7.9						
<b>GYSPOT PTI GENIUS 480V</b>	3 x 480 V	<b>14 500</b>	<b>20 (17 kVA)</b>	<b>20</b>	7	2.5+2.5+2.5	1,5 + 3	6 m, Liquid	8 m 4xAWG12 (500W)	71 x 90 x 200	128.7	

# RESISTANCE SPOT WELDING PTI NEO

NEW



**Manual Mode**  
Direct entry of welding current, time and pressure -  
Entrée directe du courant et temps de soudage et de la pression

3.5" colour screen  
Easy navigation interface



**Traceability software**  
Save spot welding configuration and export data

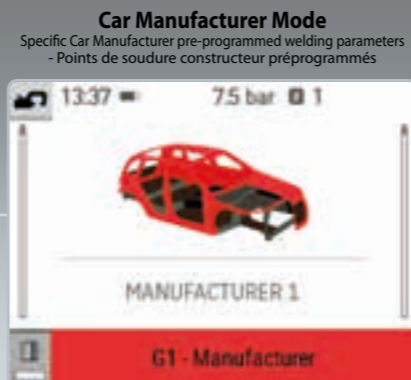

**GYSPOT PTI NEO**  
**13000 A**  
550 daN  
For mild steel, HSS, UHSS Boron steel

**TRANSFORMER INSIDE**

Liquid cooled : 5 litres

**Automatic Mode**  
Automatic detection of the welding parameters

**3.5" colour screen**  
Easy navigation interface

**Traceability software**  
Save spot welding configuration and export data

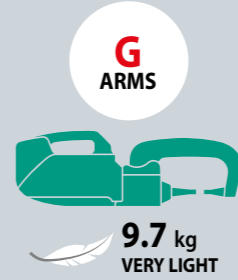

**OPTION** **NEW**

**QUICK FIX Single sided gun**  
- Kit Pistolet monopoint 082823

**EASY CONNECTION**

	024779	084834	077362	084841
Gyspot PTI-NEO	<b>400V</b>		<b>208-240V</b>	
Caps remover 050846	■	■	■	■
G1 022768	■	■	■	■
G2 + G4				
	<b>ALL IN 1 BOX</b>	<b>ALL IN 1 BOX</b>	<b>ALL IN 1 BOX</b>	<b>ALL IN 1 BOX</b>

78.5 x 58.5 x 64 cm 6 units/palette

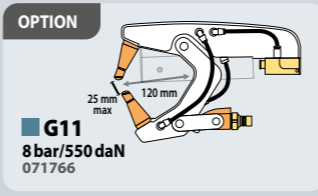
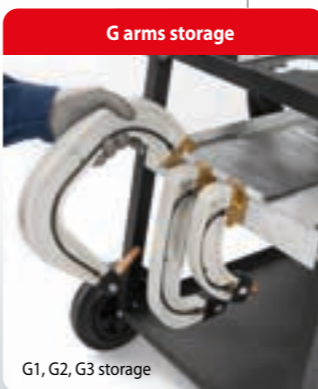

**OPTIONS**

<p><b>Caps type A box</b> 048935 x40 (x6: 049987)</p> <p><b>Caps type F box</b> 077119 x40 (x6: 049970)</p>	<p>x20 (x6: 049987)</p> <p>x6 (x6: 049970)</p> <p>x2 (x1: 050617)</p> <p>073449</p>	<p><b>EASY USB UPDATE</b></p> <p>USB key 16 Gb 062344</p>	<p>Cooling liquid - Liquide de refroidissement - Kühlmittel - Enfriamiento líquido - Refrigeração líquida</p> <p>2L 082212 5L 062511 10L 052246</p>	<p>Protection cover - Housse de protection - Schutzhaube</p> <p>062733</p>	<p><b>NEW</b></p> <p>G-clamp front body + protection 084896</p>
---	---	---	---	--	---

MADE IN FRANCE 62135	50/60 Hz	RMS A	TAM A D curve	Spots/min (max)	Uo		mm			Cables				cm	kg
					V	mm	(option)	(option)	(option)	(option)	(option)				
<b>GYSPOT PTI NEO 400V</b>	3 x 400V	<b>13 000</b>	<b>20</b>	<b>10</b>	7.7	2.5+2.0+2.0	1.5+3.0	4 m, Liquid	1.8 m, Ø 300 mm <sup>2</sup>	1 m, Ø 300 mm <sup>2</sup>	8 m 4x4 mm <sup>2</sup> HOT8NF	63 x 76 x 127	57		
<b>GYSPOT PTI NEO 208-240V</b>	3 x 200V 208V 230V 240V	<b>10 900</b> <b>11 300</b> <b>12 500</b> <b>13 000</b>	<b>30</b>	<b>10</b>	6.7 6.9 7.7 8	2.5+2.0+2.0	1.5+3.0	4 m, Liquid	1.8 m, Ø 300 mm <sup>2</sup>	1 m, Ø 300 mm <sup>2</sup>	8 m 4xAWG8 (SOOW)	63 x 76 x 127	62		

GYSPOT PTI NEO  
LIQUID COOLED





GYSPOT

RESISTANCE SPOT WELDING

# PTI MASTER PTI EXPERT



MADE IN FRANCE

GYRO INTEGRATED



PTI EXPERT only

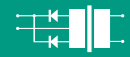

## TRANSFORMER INSIDE

MASTER 10.3 kg  
(G1 included)

EXPERT 11.8 kg  
(Gyro + G1 included)

LIQUID COOLED  
Refrroidissement liquide



### FAST OPEN XL

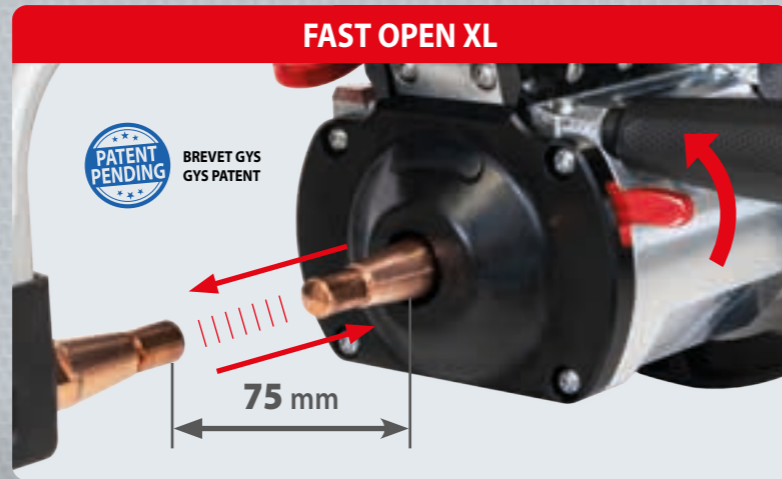

BREVET GYS  
GYS PATENT

75 mm



EASY OPENNING

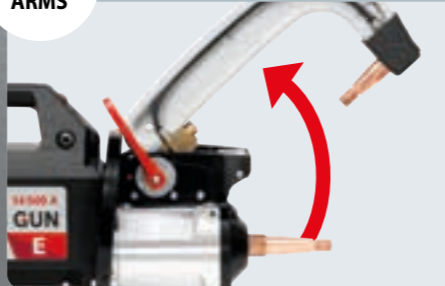

PERFECT ELECTRICAL CONNECTION



AUTOMATIC HYDRAULIC CONNECTION



For mild steel,  
HSS, UHSS  
Boron steel



**GYSPOT PTI MASTER**  
**13000 A**  
550 daN  
Liquid cooled : 5 litres

**GYSPOT PTI EXPERT**  
**14500 A**  
550 daN  
Liquid cooled : 30 litres

	083264	087965	083257	087972	083943	088009	083950	088016
PTI-MASTER	400V		208-240V		400V		208-240V	
Caps remover	■	■	■	■	■	■	■	■
G1	■	■	■	■	■	■	■	■
G2 + G3 + G4			■	■				■
G9						■		■



ALL IN 1 BOX  
MASTER  
78.5 x 58.5 x 64 cm

LIQUID COOLING  
5 Litres  
(not included)



Gyro included

LIQUID COOLING  
30 Litres  
(not included)

### OPTIONS

G-clamp front body + protection 084896



QUICK FIX Single sided gun - Kit Pistolet monopoint 082823

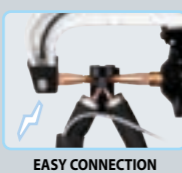

EASY CONNECTION

Cooling liquid - Liquide de refroidissement - Kühlmittel - Enfriamiento líquido - Refrigeração líquida



2L 082212  
5L 062511  
10L 052246

Protection cover for PTI MASTER 062733



Protection cover for PTI EXPERT 050853



10-14 kg  
059696

MADE IN FRANCE CE NORM. 62135	50/60 Hz	RMS A	A D curve	Spots/min (max)	Uo V	mm		Cables				cm	kg
						Uo	mm	mm	mm	(option)	(option)		
GYSPOT PTI MASTER 400V	3 x 400V	13 000	20	10	7.7	2.5+2.0+2.0	1.5 + 3.0	4 m, Liquid	1.8 m, Ø 300 mm <sup>2</sup>	1 m, Ø 300 mm <sup>2</sup>	8 m, 4x4 mm <sup>2</sup> H07RN-F	63 x 76 x 127	58
		200V 10 900											
		208V 11 300											
		230V 12 500											
GYSPOT PTI MASTER 208-240V	3 x	200V 10 900	30	10	6.7	2.5+2.0+2.0	1.5 + 3.0	4 m, Liquid	1.8 m, Ø 300 mm <sup>2</sup>	1 m, Ø 300 mm <sup>2</sup>	8 m, 4xAWG8 (500V)	63 x 76 x 127	63
		208V 11 300											
		230V 12 500											
		240V 13 000											
GYSPOT PTI EXPERT 400V	3 x 400V	14 500	25	10	7.4	2.5+2.0+2.0	1.5 + 3.0	5 m, Liquid	1.8 m, Ø 300 mm <sup>2</sup>	1 m, Ø 300 mm <sup>2</sup>	8 m, 4x4 mm <sup>2</sup> H07RN-F	65 x 100 x 230	109
		200V 12 500											
GYSPOT PTI EXPERT 208-240V	3 x	200V 12 500	50	10	6.5	2.5+2.0+2.0	1.5 + 3.0	5 m, Liquid	1.8 m, Ø 300 mm <sup>2</sup>	1 m, Ø 300 mm <sup>2</sup>	8 m, 4xAWG8 (500V)	65 x 100 x 230	119
		208V 13 000											
		230V 14 500											
		240V 14 500											



65

PTI MASTER / EXPERT

LIQUID COOLED

**FOR GYSPOT BP GENIUS, PTI NEO / MASTER / EXPERT / GENIUS**

G Arms - Caps Ø13 mm

**Bras isolés - Isolated arms - Isolierte Bügel**

**Reversible** X 104 mm

for G1, G3, G4, G5, G8, G10 & G12

Kit de maintenance connecteurs pince G - Connectors maintenance kit for G clamp 067295

for G4/G5/G8 G10/G12/G14 x25 087071 x10 087095 x10 087088 x10 087064

x4 + x1 + x1 + x1 = G arms protections kit 067288

**G2 8 bar/300 daN** 022775

**G6 8 bar/550 daN** 022812

**G7 4 bar/150 daN** 022829

**G11 8 bar/550 daN** for PTI PREMIUM PRO, NEO, MASTER & EXPERT 071766

25 mm max 120 mm

**G4 8 bar/550 daN** 022799

Option for G4

**G4-SA (Small Access)** 064478 (for arms < 01/2021)

**G5/G10-SA (Small Access)** 067660

**G8-SA (Small Access)** 067677

**G1 8 bar/550 daN** 022768

**G3 8 bar/550 daN** 022782

**G10 8 bar/400 daN** 067165

**G12 8 bar/300 daN** 075238

**G14 8 bar/550 daN** 080942

**G1/G3-SA (Small Access)** 067653 (for arms > 02/2021)

**G9 8 bar/550 daN** not for PTI PREMIUM PRO / NEO

**G9 with X1 Included** 022881

**X1** 050501 550 daN

**X2** 050518 300 daN

**X6** 050587 400 daN

Options for G9

90284 + 55121 for BP-G < Oct. 2019

Option SD card 050914

Option PCB 97449C

**G ARMS PANELS**

**G2 + G3 + G4** 022898

**G2 + G3 + G5** 063297

**KIT SMALL ACCESS GENIUS** for PTI GENIUS 077072

included SA 073579

+ **G1/G3-SA (Small Access)** + **G5/G10/G12-SA (Small Access)**

+ **G4-SA (Small Access)** + **G8-SA (Small Access)**

**X/C/G CONSUMABLES - Consommables X/C/G**

Type A Cor X clamp Ø 13 mm (x6) 049987

Type D Cor X clamp Ø 13 mm (x10) 058507

TYPE G Ø 13 mm (x10) 059672

Type B Cor X clamp Ø 13 mm / Ø 5 mm (x6) 055506

TYPE F For single sided gun Ø 13 mm (x6) 049970

Caps inclinés - Beveled X2, X4C11 arms Ø 13 mm (x6) 049994

Caps type A box 048935 x40

Caps type F box 077119 x40

073449 x20

050068 x10

050440 80 g Contact grease Graisse contact

050846 Caps remover

076822 500 ml Anti-corrosion welding primer - Primaire de soudage anti-corrosion

049291 Spot / Monopoint

**CAP GRINDER - Affuteur de caps**

Lame - Blade 052857

048966

Optimal speed: 400-800 rpm

Youtube

**GYRO 360°**

for PTI-S7 051720

**STEEL SHEET TRACTION BENCH** - Banc de traction arrache tôle - Blech-Zugbank zur Festigkeitsprüfung

052420

052321 (included)

**WELD TEST KIT - Valise test soudure HLE / THLE - Schweißtestkit im Hartschalenkoffer**

050433

Barre d'arrache / Traction bar + Acier doux / Mild steel 0.65 (x25) + 1.0 (x25) + Acier HSLA 360 - HLE 0.8 (x25) + Acier DP600 - THLE/UHLE 1.0 (x25) + Acier FB560 - THLE/UHLE 2.5 (x25)

**ANTI-ARC PROTECTION 12V** - Protection anti-arc 12 V - Lichtbogenschutz 12V - Protección anti-arco 12V

041318

**PROTECTION COVER** - Housses de protection - Schutzhaube

for BP & PTI 050853

for PTI GENIUS 077126

**SHEETS SET** - Echantillons de tôles

Acier standard / Standard steel 0.8 (x65) + 1 (x55) + 1.5 (x35) + 2 (x25) + Alu 1 (x45) + 1.5 (x30) + 2 (x20) 055841

**ELECTRODE FORCE SENSOR** - Capteur d'effort

052314

**TANK DRAINING KIT** - Kit de purge réservoir - Kit zur Tankentleerung

058286

for GYSPOT PTI-s7

**SD MEMORY CARD** - Carte mémoire SD

SD CARD 050914

2 L 082212

5 L 062511

10 L 052246

**FOR GYSPOT 32D-X, 100R-CX, BP-LX****550 daN****6,5 kg** including X1

- DOUBLE PRESSURE
- LIQUID COOLED / REFRIGÉRISSÉMENT LIQUIDE
- Ø 10 mm

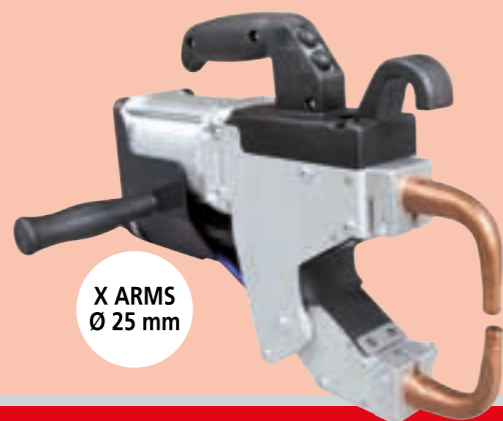
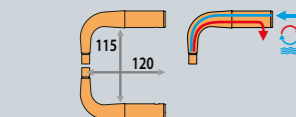
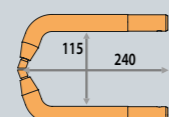
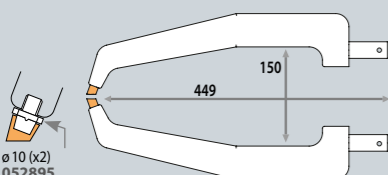
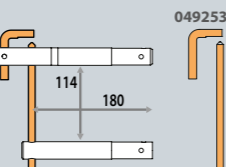
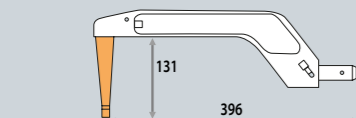
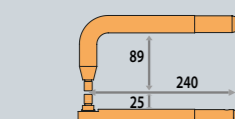

MADE IN FRANCE

**X ARMS**  
Ø 25 mm**X Arms - Caps Ø13 mm****X1 8 bar/550 daN**  
050501**X2 8 bar/400 daN**  
050518**X4 8 bar/120 daN**  
050532**X5 8 bar/200 daN**  
050549**X4A 8 bar/150 daN**  
020702**X4B 8 bar/150 daN**  
020719**X4C 8 bar/150 daN**  
020726**X6 8 bar/400 daN**  
050587**X4 (A, B & C) combinations**

- X4A + X4A
- X4A + X4B
- X4B + X4B
- X4A + X4C
- X4C + X4C
- X4B + X4C

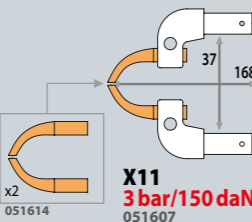
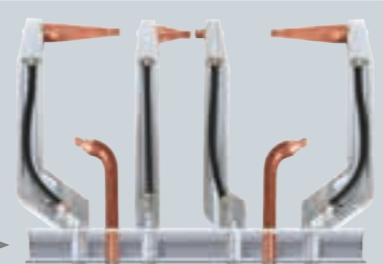
**X11 3 bar/150 daN**  
051607**X ARMS PANEL****X4A (x2) + X4B + X4C + X2**  
087798X arms support  
021471**Remote control (BP)**Digital screen control  
Change Mode & Parameters

X clamp control



C clamp control

**C ARMS PANELS**

- C2
- + C3
- + C4

**ALL IN 1 BOX** 060821

- C10 +
- C3 +
- C5 +
- C6 +
- C9

**=** 076495
**FOR GYSPOT PTI****550 daN****Transformer inside****9,9 kg** including C1

- DOUBLE PRESSURE
- AIR COOLED + LIQUID COOLED / DOUBLE REFRIGÉRISSÉMENT AIR + LIQUIDE
- Ø 10 mm

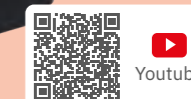
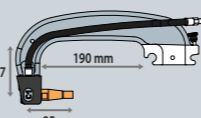
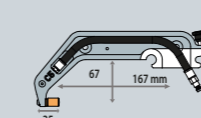
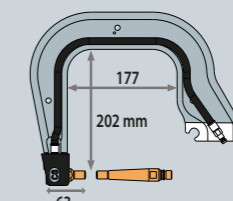
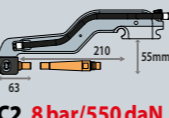
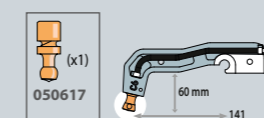
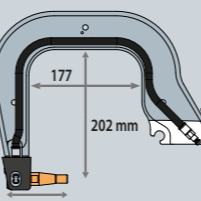
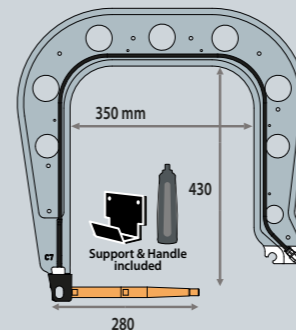
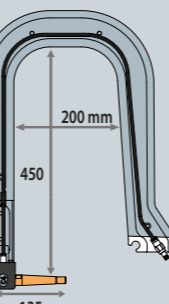
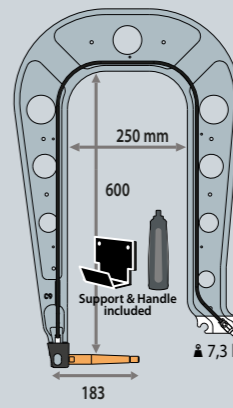
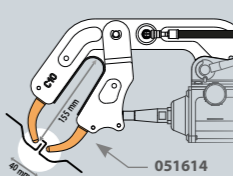
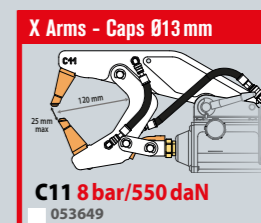
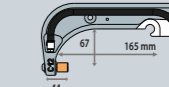
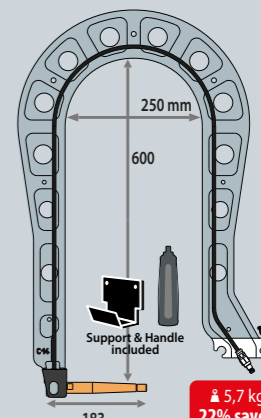
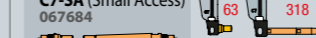
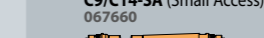
**C Arms - Caps Ø13 mm****Bras isolés - Isolated arms - Isolierte Bügel****ELECTRICAL INSULATION****C1 8 bar/550 daN**  
021402**C5 8 bar/550 daN**  
022393**C8 8 bar/550 daN**  
021440**C2 8 bar/550 daN**  
022386**C6 8 bar/300 daN**  
022409**C3 8 bar/550 daN**  
021419**C7 8 bar/550 daN**  
021433**C4 8 bar/550 daN**  
021426**C9 8 bar/550 daN**  
020078**C10 4 bar/150 daN**  
051638**C11 8 bar/550 daN**  
053649**C12 8 bar/550 daN**  
022997**C14 8 bar/400 daN**  
023543**5,7 kg**  
**22% saved**PTI arm support kit  
077577BP arm support kit  
080089Arm lock pin  
062405**Option for C7****C7-SA (Small Access)**  
067684**Option for C9 & C14****C9/C14-SA (Small Access)**  
067660



**GYS**

INVEST IN THE FUTURE



GYSPRESS

Youtube



**GYSPRESS 10T**

6.5 bar 100 kN

**10t**

063303

070653



US version  
070653



Pressure gauge  
Psi



Discharge lever  
- Levier de décharge - Auslösehebel



Speed control - Contrôle de la vitesse - Regelung  
Werkzeuggeschwindigkeit



Pressure control  
- Contrôle de la pression - Druckregelung



# RIVETING

GYSPRESS 10T	71
GYSPRESS PREMIUM 10T PP	73
GYSPRESS 10T PP CONTROL	74
ADAPTERS	76
DIES BOXES & RIVETS	78
ACCESSORIES	81

**GYSPRESS 10T COMPLETE PACKS**

<b>GYSPRESS 10T</b> 063303	✓			✓				
070653	✓							
085091								
<b>GYSPRESS 10T pack 1</b> 066441	✓				✓			
<b>GYSPRESS 10T pack 2</b> 082991	✓					✓		
<b>GYSPRESS 10T pack 3</b> 064744	✓				✓			✓

MADE IN FRANCE	AIR BAR	PRESSURE CONTROL	SPEED CONTROL			
				cm	kg	LxWxH cm / kg
<b>GYSPRESS 10T</b>	6.5 bar = 10 t (maxi 10 bar)	0 > 6.5 bar		39.5 x 180	6.2 (HR110 included)	58 x 50 x 15 / 12.1



	HR110	HR210	HR310
	063310	063327	063334
GYPESPRESS 8T	✓	✓	—
GYPESPRESS 10T	✓	✓	✓
GYPESPRESS 8T PUSH PULL	✓	✓	✓
GYPESPRESS PREMIUM 10T PUSH PULL	✓	✓	✓
GYPESPRESS 10T PUSH PULL	✓	✓	✓
GYPESPRESS 10T CONNECT	✓	✓	✓



**KIT WITH HR210 + HR310**  
064089

**XT31-40**  
Rallonges bras HR310 pour point milieu - HR310 arm extension for middle point

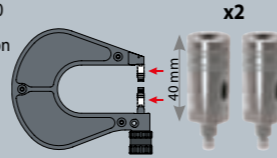

Compatible 8T PP/10T/10T PP x2  
066335

**OPTIONS**



Riveting machine support for changing accessories (arms & dies)  
- Support Riveteuse pour changements d'accessoires (bras & matrice)  
- Supportständer

↳ 28 x 40 x 21,5 cm  
↳ 45 x 39 x 20 cm / 7,2 kg  
054158



Trolley - Chariot

↳ 74 x 51 x 81 cm  
↳ 80 x 123 x 15 cm / 44 kg  
054233



Trolley + Support  
Chariot + Support

↳ 51 x 74 x 122 cm  
↳ 51,2 kg  
055391

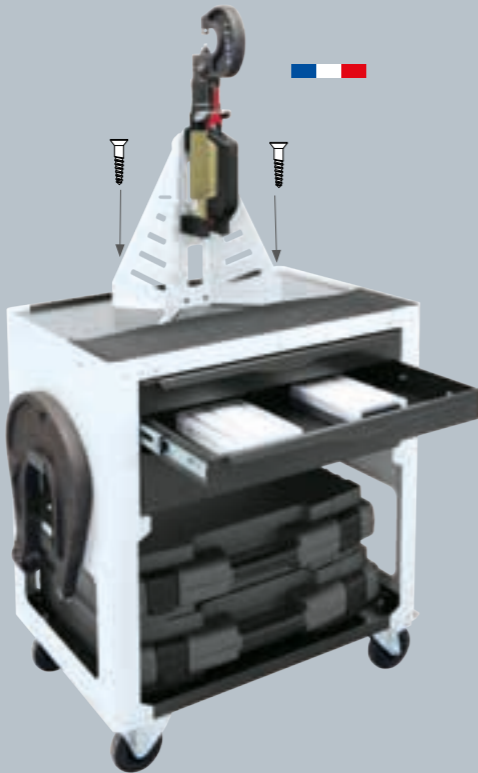

Pressure sensor - Capteur d'effort 062115



Hydraulic body wrenches (x2) 067325



Temporary - Serre-tôles - fasteners manual mounting

- (x10) Ø 2,4 mm 069664
- (x10) Ø 4,0 mm 069671
- (x10) Ø 4,8 mm 069688
- (x10) Ø 6,4 mm 069695

**GYPESPRESS 10T PREMIUM PUSH PULL COMPLETE PACKS**

	HR110 063310	XT11.21 - Extension for HR110 & HR210 058644	Standard 10T tool box 058631	6 x 50 rivets RAP - Nieten SPR 048706	HR210 + HR310 064089	24kN adapter 063822	Trolley+support 055391
<b>GYPESPRESS 10T PREMIUM PUSH PULL</b> 077065	✓						
070660							
<b>GYPESPRESS 10T PPP pack 1</b> 082519		✓					
<b>GYPESPRESS 10T PPP pack 2</b> 082526			✓				
<b>GYPESPRESS 10T PPP pack 3</b> 082533					✓		

**PREMIUM**  
PUSH PULL

**GYPESPRESS PREMIUM 10T PUSH PULL**

6.5 bar 100 kN

**10t**

077065

070660



**US version**  
070660



Pressure gauge  
Psi



**UNIQUE 100%**  
**No air inclusion**  
maintenance free, no oil refill

**UNIQUE PUSH PULL SYSTEM** by GYS

AUTO or MANUAL

← PUSH → PULL →

**LARGE OPENING**

**MORE ACCESS**

**48.5 mm**  
(no dies)  
23,5 mm with B1/B2 dies

**ERGONOMIC WITH QUICK SELECTION**

**WORK FASTER**

Push/Pull selection  
- Sélection Push/Pull

**MANUAL PULL MODE**

**OPENING CONTROL**

Manual/Automatic selection  
- Sélection Manuel/Automatique

**Pressure control**  
- Contrôle de la pression  
- Druckregelung

**Speed control**  
- Contrôle de la vitesse  
- Regelung Werkzeuggeschwindigkeit

**NEW**

**Option**  
Hydraulic pump removal tool -  
Outil de démontage de pompe  
hydraulique 086852

MADE IN FRANCE	AIR BAR	PRESSURE CONTROL	SPEED CONTROL	cm	kg	LxWxH cm / kg
	<b>GYPESPRESS 10T PREMIUM PUSH PULL</b>	6.5 bar = 10 t (maxi 10 bar)	0 > 6.5 bar	↔	39.5 x 180	6.7 (HR110 included)



GYPRESS

# SYNERGIC RIVETING WORKSTATION

PNEUMATIC HYDRAULIC



UNIQUE

100%

No air inclusion  
maintenance free, no oil refill

## ACCESSIBILITY

16 languages

- FR PR CN
- GB CZ JP
- DE NL VN
- IT SE FI
- ES RU TR

★★★★  
**SYNERGIC RIVETS SETTINGS**

Main panel

Setup instructions



Results



## 3 MODES

- MANUAL
- SYNERGIC
- CAR MANUFACTURERS

## CAR MANUFACTURERS COMPATIBILITY

- ✓ VW GROUP
- ✓ MERCEDES-BENZ
- ✓ BMW
- ✓ TESLA
- ✓ FERRARI
- ✓ FORD
- ✓ RENAULT ALPINE
- ✓ GM

## CONNECTIVITY

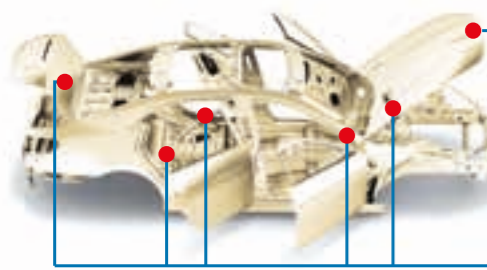

### TRACEABILITY

History data export

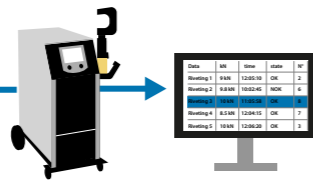

### SOFTWARE UPDATE

Gyspress evolutions

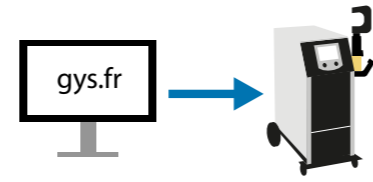

UNIQUE PUSH PULL SYSTEM by GYS

### PUSH PULL SYSTEM by GYS

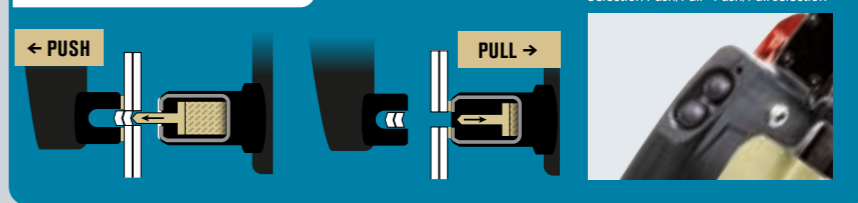

Gyspress support



Arms support



included

- HR110 063310
- XT11.21 - Extension for HR110 & HR210 058644
- Standard 10T PushPull tool box 058361
- 6 x 50 rivets RAP - Nieten SPR 048706
- Strap-Sangle-Gurt
- HR arm locker
- Poignée-Handle-Griff

### WORKSTATION GYPRESS 10T PP CONTROL

6.5 bar 100 kN

10t

063860

REGULATED PRESSURE CONTROL

POWER 10t

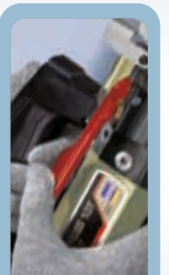

Discharge lever - Levier de décharge - Auslösehebel

### OPTIONS

Pressure gauge - Capteur d'effort 10T PP CONTROL 071759



Youtube

Hydraulic body wrenches for GYPRESS 10T, 10T PushPull, 10T PP CONTROL (x2) 067325



Hydraulic pump removal tool 086852



MADE IN FRANCE WORKSTATION GYPRESS 10T PP CONTROL	230V	AIR BAR 6.5 bar = 10t (maxi 10 bar)	PRESSURE CONTROL 0 > 6.5 bar	SPEED CONTROL + -	↕	📦
					LxWxH cm / kg 74 x 50 x 116 / 54	LxWxH cm / kg 76 x 42 x 94 / 64.4

**BLIND RIVET ADAPTERS**  
- ADAPTATEURS POUR RIVETS AVEUGLES

GYPESPRESS

Adaptators

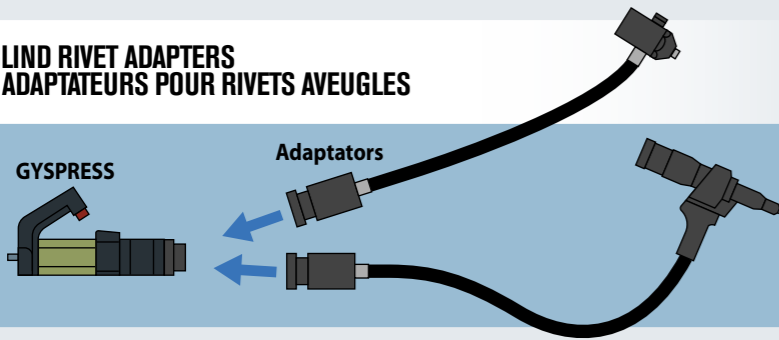

**Compatibility**

- GYPESPRESS 10T
- GYPESPRESS 10T PUSH PULL
- GYPESPRESS 10T PUSH PULL PREMIUM
- GYPESPRESS 10T CONNECT



Youtube

**BLIND RIVET ADAPTER 24 kN** - Adaptateur 24 kn pour rivets aveugles - Blindnietadapter 24 kN

**24 kN STANDARD** 600 mm  
063822

Pour rivets POP - For BLIND rivets - Für Blindniet  
Acier / Steel: Ø 4.0 → 6.4  
Alu: Ø 4.0 → 7.8



**INCLUDED**

- 058446 (included)
- for standard rivets:
  - Ø 3.2 x 1 059221
  - Ø 3.6 x 1 059238
  - Ø 4.0 x 1 059245
  - Ø 4.5 x 1 059252

**24 kN COMPACT** 600 mm  
077164

Pour rivets POP - For BLIND rivets - Für Blindniet  
Acier / Steel: Ø 6.4  
Alu: Ø 6.4 → 7.8

**COMPACT HEAD**

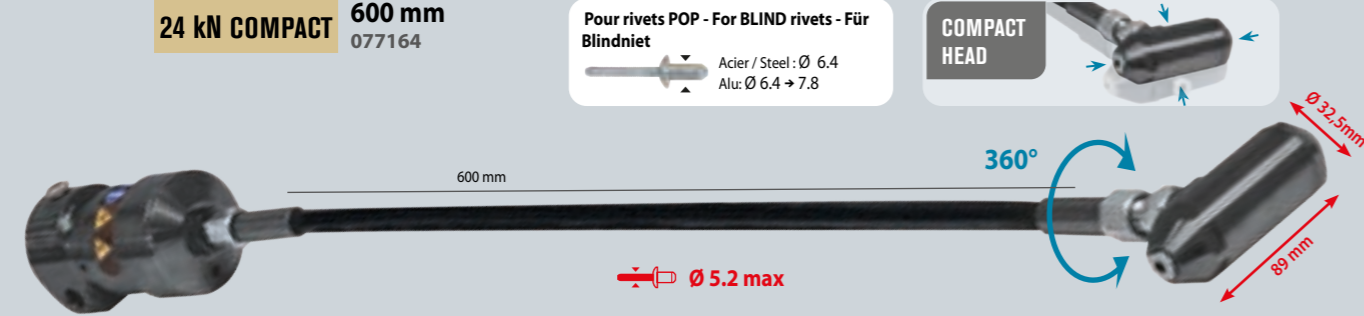

**INCLUDED**

- 058446 (included)
- for standard rivets:
  - Ø 4.5 x 1 081222
  - Ø 5.2 x 1 079939

**OPTION**

- for extraction of self piercing rivet:
  - Rivet-extraction insert
  - Buse d'extraction 24kN compact
  - Ø 5 079946

**HIGH ACCESSIBILITY**



**SPECIFIC STORAGE**



**PERFECT COMBO WITH ARCPULL**

**SPECIAL TEARING RIVETS**  
- Spécial arrachage de rivets  
- Spezial-Zugnieten

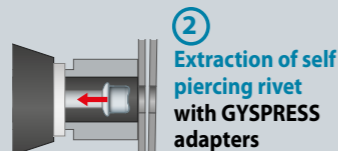
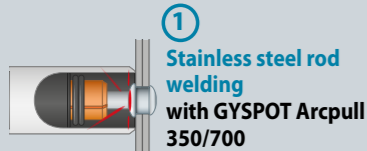

**OPTION FOR GYSPOT ARCPULL (details p.17)**

for GYSPOT ARCPULL 350

ARC PULL RIVET BOX1 350 - 24kN 064584					
Stainless steel nail - Tige inox Ø 4 x 50 mm 064607	Barrel for stainless steel nail welding - Canon pour pose de tige inox	Mandrel support - Support porte-goujon 059634	Nozzle + pad - Buse + patin 059641	mandrel Ø4mm 049000	Buse d'extraction 24kN Ø 4 064683
x100	x1	x1	x1	x1	x1

**BLIND RIVET ADAPTER 50 kN** - Adaptateur 50 kn pour rivets aveugles - Blindnietadapter 50 kN



Stroke adjustment - Réglage de la course de traction  
0 → 25 mm

**50 kN** 1 m  
064867  
4.0 kg

For BLIND rivets - Pour rivets POP - Für Blindniet

Steel / Acier: Ø 4.0 → 6.4  
Alu: Ø 4.0 → 7.8

**INCLUDED**

**Kit Standard**



**Complete kit** 065987



**OPTIONS**

Steel / Acier: Ø 4.0 → 6.4  
Alu: Ø 4.0 → 7.8

**160 mm extension - Extension 160 mm - Verlängerung 160 mm**  
066144



Ø 8.0 → 9.8

**Ø8.0/9.8mm nozzle-piece kit - Kit Rivets Ø8.0/9.8mm - Mundstückkit 8,0/9,8 mm**  
066045



M5 → M14  
M5 → M8

**Blind rivet nut pulling, Blind rivet bolt adapter kit - Kit 6 tirants pour pose d'écrous à sertir et goujons à sertir - Blindnietmuttern, Blindnietgewindebolzen-Kit**  
066076



**OPTION FOR GYSPOT ARCPULL (details p.17)**

for GYSPOT ARCPULL 350

ARCPULL RIVET BOX2 350 - 50kN 073388				
Long barrel + mandrel M5 - Canon long + mandrin M5 070738	Mandrel support - Support porte-goujon 059634	Buse + pad 059641	Buse d'extraction 50Kn Ø 5 066151	Mandrel support - Support porte-goujon 071377
x100	x1	x1	x1	x1

for GYSPOT ARCPULL 700

ARCPULL RIVET BOX 700 068452										
Long barrel + mandrel M5 - Canon long + mandrin M5 070738	Buse d'extraction 50Kn Ø 5 066151	Mandrel support - Support porte-goujon 071377	Buse + pad 059641	Ring holder 059610	Ring holder 059610	Rod for pulling rings - Fourche pour anneau 071384	Vis de butée	Ring holder 059610	Rod for pulling rings - Fourche pour anneau 071384	Vis de butée
x100	x1	x1	x1	x2	x1	x1	x1	x1	x1	x1

**CONSUMABLES BOX FOR 50KN ADAPTER** - Boîte consommables pour adaptateur 50kN - Zubehörbox für 50 kN Adapter

066168						Blind rivet nuts - Écrous à sertir			Blind rivet bolts - Goujons à sertir			Blind rivets - Rivets aveugles			
M5	M6	M8	M10	M12	M14	22.5 → 27	24 → 28.5	23.5 → 28	Ø 6.4	Ø 9.8	Ø 6.4	Ø 9.8	Ø 6.4	Ø 9.8	
0.5 → 3.0	0.5 → 3.0	0.5 → 3.0	1.0 → 3.5	1.0 → 4.0	4.5 → 6.0	0.5 → 3.0	0.5 → 3.0	0.5 → 3.0	2.8 → 4.8	3.0 → 14.0	0.5 → 3.0	0.5 → 3.0	0.5 → 3.0	0.5 → 3.0	
x50	x50	x50	x50	x50	x10	X50	X50	X50	x50	x50	x50	x50	x50	x50	
066175	066182	066199	066205	066212	066229	066236	066243	066250	066267	066274	066236	066243	066250	066274	
+ demo metal sheet - plaque de démonstration						+			+		+		+		
						x10 x10 x10 x10 x10 x5			x10 x10 x10			x10 x10			

<p>Application of self-piercing rivets - Pose de rivets auto-perçants - Stanzniet-Verpressen</p> <p>2.0 &lt; 6.5 mm    3 &lt; 5.8 bar</p>	<p>Application of solid rivets - Pose de rivets pleins - Vollniet-Verpressen</p> <p>2.3 &lt; 8.3 mm    5.3 &lt; 8 bar</p>	<p>Application of Flow-form rivets - Pose de rivets Flow-Form - Setzen v. Fließformnieten</p> <p>2.3 &lt; 8.3 mm</p>	<p>Extraction de rivets - Extraction of rivets - Niet-Auspressen</p> <p>2.3 &lt; 8.3 mm    8 bar</p>	<p>Metal sheet punching and shaping - Perçage et formage des tôles pour rivets pleins - Vollniet-Lochstanzen/Prägen</p> <p>2.3 &lt; 8.3 mm    8 bar</p>
---	---	--	--	---

**DIES BOXES - Boîtes matrices - Matrzensätze**

**STANDARD**

**STANDARD 8T/10T**  
for 8T 10T  
053694  
Included XT11-21 058644

x1	x1	x1	x1	x1	x1	x1	x2	x1	x1	x1	x1	x1	x2	x4
A1	A2	B1	B2	F1	F2	D17	E1	E2	T1	T2				
Self-piercing rivets				Flow-form rivets		Extraction		Punching		key	seals			
Ø 3.2 > 3.5	Ø 3.3	Ø 5 > 5.3	Ø 5.3	Ø 6 - A1/2/3 S0/1/2/3/4/5/6		Ø 3.3 > 4.8    Ø 3.9 > 5.3		Ø 6		- clé	- joints			x1

**STANDARD 8T/10T PUSH PULL**  
for 8T PP 10T PP 10T CONTROL  
058361  
Included XT31-60 - 60 mm extension for HR310 (use with ST1, T5, T7) 057135  
+ XT11-21 058644

x1	x1	x1	x1	x1	x1	x2	x1	x1	x1	x1	x1	x2	x4
A1	A2	B1	B2	F1	F2	D17	E1	E2	ST1	T5	T7		
Self-piercing rivets				Flow-form rivets		Extraction		Punching		key	seals		
Ø 3.2 > 3.5	Ø 3.3	Ø 5 > 5.3	Ø 5.3	Ø 6 - A1/2/3 S0/1/2/3/4/5/6		Ø 3.3 > 4.8    Ø 3.9 > 5.3		Ø 6		- clé	- joints		x1

Ideal for aluminum & mild steel - Idéal aluminium et aciers doux

**Low pressure** Ø 6.4 mm

**HIGH pressure** Ø 6.4 mm

**BREVET GYS / GYS PATENT** n° US 11,712,732

**Ne pas utiliser avec une Gyspress 8T & 8T PP - Do not use with Gyspress 8T & 8T PP**

Flow-Form Ø 6 mm	Flow-Form Ø 8 mm	Punching Ø 10 mm holes																											
<b>KIT RMB PP05</b> for 10T PP 10T CONTROL 066366	<b>KIT RMB 08 PREMIUM</b> for 10T 10T PP 10T CONTROL 066403	<b>KIT RMB 14 PREMIUM</b> for 10T 10T PP 10T CONTROL 071186																											
<table border="1"> <tr><td>x1</td><td>x1</td><td>x1</td></tr><tr><td>ST3</td><td>T12</td><td>T13</td></tr><tr><td colspan="3">Punching Ø 6.7</td></tr></table>	x1	x1	x1	ST3	T12	T13	Punching Ø 6.7			<table border="1"> <tr><td>x1</td><td>x1</td><td>x1</td></tr><tr><td>T14</td><td>T15</td><td>T16</td></tr><tr><td colspan="3">Punching Ø 6.7</td></tr></table>	x1	x1	x1	T14	T15	T16	Punching Ø 6.7			<table border="1"> <tr><td>x1</td><td>x1</td><td>x1</td></tr><tr><td>T17</td><td>T18</td><td>T19</td></tr><tr><td colspan="3">Punching Ø 6</td></tr></table>	x1	x1	x1	T17	T18	T19	Punching Ø 6		
x1	x1	x1																											
ST3	T12	T13																											
Punching Ø 6.7																													
x1	x1	x1																											
T14	T15	T16																											
Punching Ø 6.7																													
x1	x1	x1																											
T17	T18	T19																											
Punching Ø 6																													

**GM**

**RMB 11** for 10T 071087

**RMB PP04** for 10T PP 10T CONTROL 071063

Included XT31-60 - 60 mm extension for HR310

x1	x1	x1	x1	x1	x1	x1	x1	x1	x1	x1	x3	x1	x1	x2	x2	x4	
F1	F2	F6	E9	E11	T1	T2						T17	T18	T19	D18	D17	
Flow-form rivets			Extraction		Punching										key	seals	
Ø 6			Ø 6 > 8		Ø 6										- clé	- joints	

**FERRARI**

**RMB 06** for 8T 10T 8T PP 10T PP 10T CONTROL 059009

x1	x1	x1	x1	x1	x1	x2	x1	x1	x1	x2	x4
B4	B5	B6	S3	S7	S8	D17	E1	E2	E13		
Self-piercing rivets					Extraction		Punching		key	seals	
Ø 3.9    Ø 4.75    Ø 3.9    Ø 4.75					Ø 3.3 > 4.8    Ø 3.9 > 5.3		Ø 4.75		- clé	- joints	

**VW GROUP**

**RMB 03** for 8T 10T 8T PP 10T PP 10T CONTROL 054257

x1	x1	x1	x1	x1	x1	x1	x1	x1	x1	x1	x1	x1	x1	x1	x1	x1	x1	x1	x2	x4				
A1	B1	S3	S7	S8	D8	D9	D17	D1	D2	D3	D4	D13	E2	S1	S4	S5	D5	D6	D7	D10	D11	D12	D15	D16
Self-piercing rivets				Solid rivets		Extraction										Punching		key	seals					
Ø 3.2 > 3.5    Ø 5 > 5.3    Ø 3.9    Ø 4.75				Ø 4    Ø 6		Ø 3.2    Ø 5.3    Ø 3.9 > 5.3    Ø 3.2    Ø 5.3    Ø 8    Ø 4.8    Ø 4 > 8    Ø 4    Ø 6										Ø 6		- clé	- joints					

**NIO**

**RMB PP08** for 10T 10T PP 10T CONTROL 072404

Included XT31-60 - 60 mm extension for HR310

x1	x1	x1	x1	x1	x1	x1	x1	x1	x1	x1	x1	x3	x1	x2	x1	x2	x4
B1	B2	F1	F2	F6	E2	E3	E9	E11	T5	ST1	T7	T17	T18	T19	D17	D18	
Self-piercing rivets		Flow-form rivets		Extraction		Punching									key	seals	
Ø 5.3    Ø 5.3		Ø 6		Ø 5.3    Ø 6		Ø 6									- clé	- joints	

**MERCEDES-BENZ**

**RMB 07** for 10T 064454

Included XT31-60 - 60 mm extension for HR3 (use with E3, E4, E5, E9, E10, E11) 057135

x1	x1	x1	x1	x1	x1	x1	x1	x1	x1	x1	x1	x1	x1	x2
F1	F2	F3	F45	F5	E9	E10	E11	T1	T2	T3	T4			
Flow-form rivets					Extraction		Punching				clé			
Ø 6 - A1/2/3 S0/1/2/3/4/5/6					S28/38/48/58/68    S08/18		Ø 6 > 8    Ø 8    Ø 6		Ø 6    Ø 6    Ø 8    Ø 8				- key	

**RMB PP01** for 8T PP 10T PP 10T CONTROL 058378

Included XT31-60 - 60 mm extension for HR3

x1	x1	x1	x1	x1	x1	x1	x1	x1	x1	x1	x1	x1	x1	x1	x1	x2
F1	F2	F3	F45	F5	E9	E10	E11	ST1	ST2	T5	T7	T8	T10			
Flow-form rivets					Extraction		Punching				clé					
Ø 6 - A1/2/3 S0/1/2/3/4/5/6					S28/38/48/58/68    S08/18		Ø 6 > 8    Ø 8    Ø 6		Ø 6    Ø 8    Ø 6    Ø 8    Ø 8				- key			

**FORD**

**RMB PP02** for 10T 8T PP 10T PP 10T CONTROL 058835

Included XT31-60 - 60 mm extension for HR3 (use with E7 & E12) 057135

x1	x1	x1	x1	x1	x1	x1	x1	x1	x1	x1	x2	x4
B1	G1	G2	G3	G4	G5	G6	E7	E12				
Self-piercing rivets								Extraction		key	seals	
Ø 5 > 5.3								Ø 5 > 5.3		- clé	- joints	

**JAGUAR / LAND ROVER**

**RMB 02** for 8T 10T 8T PP 10T PP 10T CONTROL 054271

x1	x1	x1	x1	x1	x1	x2	x1	x1	x2	x4
B1	B2	B3	S8	D17	E1	E6				
Self-piercing rivets					Extraction		clé	seals		
Ø 5 > 5.3    Ø 5.3    Ø 4.8    Ø 4.75					Ø 3.3 > 4.8    Ø 3.3 > 4.8		- key	- joints		

**BMW**

**RMB 01** for 8T 10T 8T PP 10T PP 10T CONTROL 054240

x1	x1	x1	x1	x1	x1	x2	x4	
A1	A2	B1	B2	E1	E2			
Self-piercing rivets					Extraction		key	seals
Ø 3.2 > 3.5    Ø 3.3    Ø 5 > 5.3    Ø 5.3					Ø 3.3 > 4.8    Ø 3.9 > 5.3		- clé	- joints

**RMB 12** for 10T 071094

**RMB PP07** for 10T PP 10T CONTROL 071070

Included XT31-60 - 60 mm extension for HR310

x1	x1	x1	x1	x1	x1	x1	x1	x1	x1	x1	x1	x1	x1	x1	x3	x1	x1	x2	x2	x4
B1	B3	I1	I2	I3	F1	F2	F6	E3	E13	T1	T2					T17	T18	T19	D18	D17
Self-piercing rivets					Flow-form rivets		Extraction		Punching										key	seals
Ø 5 > 5.3    Ø 5.3					Ø 6		Ø 3.3 > 4.8    Ø 9		Ø 6										- clé	- joints

**PORSCHE**

**RMB 10** for 10T 069299

**RMB PP06** for 10T PP 10T CONTROL 069305

Included XT31-60 - 60 mm extension for HR310

x1	x1	x1	x1	x1	x1	x1	x1	x1	x1	x1	x1	x1	x1	x1	x3	x1	x2	x2	x4	
B3	F2	E9	E11			T1	T2									T17	T18	T19	D17	
Flow-form rivets		Extraction		Punching										key	seals					
Ø 6		Ø 6 > 8		Ø 6										- clé	- joints					

**TESLA**

**RMB 09** for 8T 10T 8T PP 10T PP 10T CONTROL 059931

x1	x1	x1	x1	x1	x1	x1	x1	x1	x1	x1	x1	x2	x4	
B1	H1	H2	H3	H4	H5	H6	H7	H8						
Self-piercing rivets													key	seals
Ø 5 > 5.3    Ø 5.3													- clé	- joints

**RMB 13** for 10T 071100

**RMB PP03** for 8T PP 10T PP 10T CONTROL 059092

Included XT31-60 - 60 mm extension for HR3 (use with E2, E3, E9, E10) 057135

x1	x1	x1	x1	x1	x1	x2	x1	x1	x1	x1	x1	x1	x1	x1	x1	x1	x1	x1	x2	x4
B1	S7	S8	F3	F45	F5	D17	E2	E3	E9	E10										
Self-piercing rivets					Flow-form rivets		Extraction		Punching				key	seals						
Ø 5 > 5.3    Ø 4.75					S28/38/48/58/68    S08/18		Ø 3.9 > 5.3    Ø 5.3 > 8		Ø 6 > 8    Ø 8    Ø 8    Ø 8				- clé	- joints						



**DIES - Matrices - Matrizen**

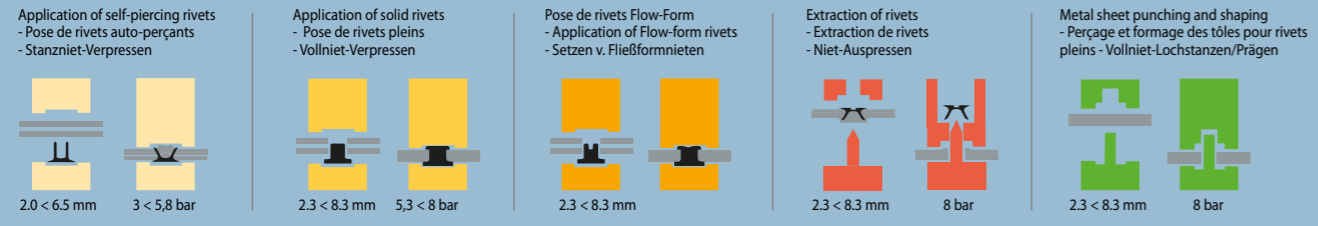

Ø 8																				
A1	A2	B1	B2	B3	B4	B5	B6	D1	D2	D3	D4	D5	D6	D7	D8	D9	D10	D11	D12	D13
055698	055704	055711	055728	055735	059016	059023	059030	055971	055988	055995	055742	056008	056015	056022	056039	056046	055674	056060	056053	055759
A1+A2		B1+B2																		
054295		054301																		

D15	D16	D17	D18	E1	E2	E3	E6	E7	E9	E10	E11	E12	E13	F1	F2	F3	F45		
056077	056084	055681	071155	055865	054288	055766	057005	057142	057159	058606	058613	058620	058828	059085	055773	055780	055797	083547	
				E1+E2												F1+F2			
				054318												054714			

F5	F6	G1	G2	G3	G4	G5	G6	H1	H2	H3	H4	H5	H6	H7	H8	I1	I2	I3	J1	J2
055810	071148	057173	057180	057197	057203	057210	057227	068230	068247	068254	068261	068278	068285	068292	068308	071117	071124	071131	071674	071902

Ø 6				Ø 6				Ø 6				Ø 8				Ø 6.7			
S1	S3	S4	S5	S7	S8	ST1	ST2	ST3	T1	T2	T3	T4	T5	T7	T8	T10	T12	T13	
057036	057043	057050	057067	057074	057081	058071	058088	066397	057098	059078	057104	055827	055834	058019	058033	058040	058064	066373	066380
																T1+T2			
																054707			

**BREVET GYS / GYS PATENT**  
n° US 11,712,732

Ø 6.7		Ø 6		Ø 8		Ø 10	
x1	x1	x5	x1	x1	x1	x5	x1
T14	T15	T16	T17	T18	T19	T20	T21
066410	066427	068964	066434	069312	069329	071254	069336
070936	070943	071261	070950	082830	082847	082861	082854

Pressure chart: 3-5.2 bar (RAP Ø3.3), 4.7-5.8 bar (RAP Ø3.3), 5.3-6.4 bar (RFF Alu Ø6), 5.8-7 bar (RFF Steel Ø6), 6.5-8 bar (RFF Steel Ø8), 8 bar (Eject & Punching)

**SELF PIERCING RIVETS (SPR)**  
- Rivets auto-perçants (RAP) - Stanznieten

Steel - Acier - Stahl

Complete box 048706							
Ø 3,3 x 3,5 mm x 50	Ø 3,3 x 4 mm x 50	Ø 5,3 x 4 mm x 50	Ø 5,3 x 5 mm x 50	Ø 5,3 x 6 mm x 50	Ø 5,3 x 8 mm x 50	Ø 5,3 x 7 mm	Ø 5,3 x 9 mm
x200 048232	x200 048249	x100 048256	x100 048263	x100 048270	x100 048225	x100 048638	x100 048645

**SPECIAL CENTER PUNCH**  
- Pointeau centreur - Spezialekörner



**HYDROPNEUMATIC TOOL FOR BLIND RIVETS**  
- Riveteuse hydro-pneumatique - Hydro-pneum. Blindnietgerät

For BLIND rivets - Pour rivets POP - Für Blindniet  
max Ø 4.5    Ø 4.8/6.4

**HR185**

**max 18 500 N (5-7 bar)**  
H 327 x L 21 mm / 2.3 kg

085923

Suction - Aspiration

**CORDLESS RIVETER** - Riveteuse sur batterie  
- Akku-Blindnietgerät

For BLIND rivets - Pour rivets POP - Für Blindniet  
Ø 4.0/4.8/5.0/6.0/6.4

**TWO ER20**

**max 20 000 N (6 bar)**  
10-20 V universal fast charger (30 min)  
2.0 kg

064461

BRUSHLESS motor

2 x 20V/2Ah Li-ion battery

**HYDROPNEUMATIC TOOL FOR BLIND RIVETS** - Riveteuse hydro-pneumatique - Hydro-pneum. Blindnietgerät

For BLIND rivets - Pour rivets POP - Für Blindniet

Steel / Acier    Ø 4.0/4.8/6.4  
Alu                Ø 4.0/4.8/6.4

**HR14**

**max 14 000 N**

057241

Made in Taiwan

**MANUAL TOOL FOR BLIND RIVETS**  
- Riveteuse manuelle - Manueller Blindnietgerät

For BLIND rivets - Pour rivets POP - Für Blindniet

Steel / Acier    Ø 3.2/4.0/4.8/6/6.4  
Alu                Ø 3.2/4.0/4.8/6/6.4

**061323**

Made in Taiwan

**HYDROPNEUMATIC TOOL FOR RIVET NUTS** - Sertisseuse hydro-pneumatique riv 998 - Hydro-pneum. Blindnietmuttergerät

Sealing nuts - Ecrous à sertir - Blindnietmutter    M3 → M12  
Blind rivet bolts - Goujons à sertir - Blindnietbolzen    M3 → M12

**RIV 998**

**max 19 000 N (6 bar)**  
included accessories for sealing nuts:  
- livré avec accessoires pour écrous à sertir:

- ✓ M3            ✓ M4
- ✓ M5            ✓ M6
- ✓ M8            ✓ M10
- ✓ M12

055414

MADE IN ITALY

**HYDROPNEUMATIC TOOL FOR BLIND RIVETS**  
- Riveteuse hydro-pneumatique - Hydro-pneum. Blindnietgerät

For BLIND rivets - Pour rivets POP - Für Blindniet

Steel / Acier    Ø 3.2/4.0/4.8  
Alu                Ø 3.2/4.0/4.8

**HR9**

**max 9 000 N**

057234

Made in Taiwan



# MIG-MAG GMAW-FCAW

**TRADITIONAL**

GYS AUTO 83

**INVERTER**

E GYS AUTO 84

P GYS AUTO 86

AUTOPULSE 88

**ACCESSORIES & CONSUMABLES** 92

## MIG/MAG TRADITIONAL SYNERGIC

**15 → 200 A**  
Ideal 0,6 mm

**Capacitor**  
M1 GYS AUTO, M3 GYS AUTO  
> PERFECT WELD

Without Capacitor

With capacitor

ENERGY SAVING

ACCESSORIES BOX

**M1 GYS AUTO**

15 → 160 A Capacitor

230V • 1~ 6 m

032903

208/240V • 1~ 2 m

032088

with accessories

**M3 GYS AUTO**

15 → 160 A Capacitor

230V • 1~ 6 m

032880

Ø 300mm / 200mm

OPTION Ø 100mm

**Option Spool Gun Torch**  
041486

Ø 100

Ideal for

- Steel / Acier / Stahl
- Stainless steel / Inox
- Alu

**100% READY**

Ø 100mm

Ø 200mm

Ø 300mm / 200mm

**Option M3 GYS:**  
Protection cover 052260



MADE IN FRANCE	MADE IN CHINA	CE NORM	50/60 Hz	A	A	Reg	100 (spoolgun) 200 300	Electronic Control	EN60974-1 (40°C)		Ø mm	Ø mm	Ø mm	LxWxH cm / kg	Protected & compatible power generator (+/-15%)
									IA (60%)	X% (I2 max)					
		M1 GYS AUTO	230V 1~ 208/240V 1~	16	15 → 160	6	option		90	140A@15%	0.6+1	0.6/0.8	0.8	78 x 38 x 67 / 56 37 x 79 x 67 / 57.5	4,5 kVA
		M3 GYS AUTO	230V 1~	16	15 → 160	6			90	140A@15%	0.6+1	0.6/0.8 0.8/1.0	2 x 0.8	74 x 40 x 85 / 77.5	4,5 kVA



E GYS AUTO

# MIG/MAG INVERTER SYNERGIC

Lastest generation  
colour screen 3.5"

EASY



EXPERT

Pre-gas / Creep speed/ Hotstart /  
Crater filler / Burnback / Post-gas



Screen protection -  
Protection d'écran -  
Bildschirmschutz  
079885



## EASY TO SETUP



## MODES

- MANUAL
- SYNERGIC EASY / EXPERT
- 2T
- 4T
- SPOT
- DELAY

## FONCTIONS

- TRACEABILITY
- PORTABILITY
- +500 JOBS can be saved

## SYNERGIES

- STEEL
- AlSi
- AlMg
- Cu Si 3 / CuAl 8
- CrNi

## UPDATES



EASY USB  
UPDATE

USB key 16 Gb  
062344

E1 GYS AUTO

10 **200 A** 230V 1~ PFC

with accessories :

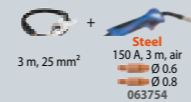

3 m, 25 mm<sup>2</sup>

Steel  
150 A, 3 m, air  
Ø 0.6  
Ø 0.8  
063754

075122

E2 GYS AUTO

10 **200 A** 230V 1~ PFC

with accessories :

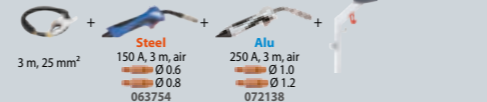

3 m, 25 mm<sup>2</sup>

Steel  
150 A, 3 m, air  
Ø 0.6  
Ø 0.8  
063754

Alu  
250 A, 3 m, air  
Ø 1.0  
Ø 1.2  
072138

075139

E3 GYS AUTO

10 **200 A** 230V 1~ PFC

with accessories :



3 m, 25 mm<sup>2</sup>

CuSi  
150 A, 3 m, air  
Ø 1.0  
072121

Steel  
150 A, 3 m, air  
Ø 0.6  
Ø 0.8  
063754

Alu  
250 A, 3 m, air  
Ø 1.0  
Ø 1.2  
072138

075160



4 m<sup>3</sup>  
(20L)

1 x

6 m



2 x 4 m<sup>3</sup>  
(20L)

2 x

6 m

6 m

3 x

E1 GYS AUTO 200 A • × 1

E2 GYS AUTO 200 A • × 2

E3 GYS AUTO 200 A • × 3

MADE IN FRANCE	CE NORM. 60974/1	50/60 Hz	A	6 m	min → max A	Ø mm		Electronic Control	EN60974-1 (40°C)		Original equipment Equipement d'origine Originalausstattung Equipamiento de fabrica	LxWxH cm / kg	Protected & compatible power generator (+/-15%)	
						200	300		IA (60%)	X% (I2 max)				Ø mm
▪	E1 GYS AUTO	230V 1~	16	6 m	10 → 200	▪	▪		145	200 A @ 20%	0.6 → 1	Acier Type B 0.6/0.8	79 x 37 67 / 42.6	9KVA
▪	E2 GYS AUTO	230V 1~	16	6 m	10 → 200	▪	▪		145	200 A @ 20%	0.6 → 1	Acier Type B 0.6/0.8 Alu Type B 0.8/1	72 x 37 x 105 / 59.5	9KVA
▪	E3 GYS AUTO	230V 1~	16	6 m	10 → 200	▪	▪		145	200 A @ 20%	0.6 → 1	Acier Type B 0.6/0.8 Acier Type B 0.8/1 Alu Type B 0.8/1	73 x 38 x 108 / 64	9KVA

E GYS AUTO  
SYNERGIC MIG  
GMAW  
FCAW





P GYS AUTO

# MIG/MAG PULSE SYNERGIC

Lastest generation colour screen 3.5"

### 16 languages

- French
- English
- German
- Italian
- Spanish
- Portuguese
- Czech
- Polish
- Dutch
- Swedish
- Russian
- Chinese
- Japanese
- Vietnamese
- Finnish
- Turkish

### EASY



### EXPERT

Pre-gas / Creep speed / Hotstart / Crater filler / Burnback / Post-gas



### EASY TO SETUP



Screen protection - Protection d'écran - Bildschirmschutz 079885

### MODES

#### EASY

- SYNERGIC STANDARD
- SYNERGIC PULSE

NEW

#### PULSE IN PULSE

#### EXPERT

- MANUAL
- SYNERGIC STANDARD
- SYNERGIC PULSE

NEW

#### PULSE IN PULSE

### TORCH

#### 2T

#### 4T

#### SPOT

#### SPOT DELAY

### FONCTIONS

#### TRACEABILITY

#### PORTABILITY

+500 JOBS can be saved

### SYNERGIES

#### STEEL - ACIER

#### ALU

#### STAINLESS STEEL - INOX

#### BRAZING - BRASAGE

#### +40 SYNERGIES

### UPDATES



EASY USB UPDATE

USB key 16 Gb 062344

**10 → 220 A**  
Ideal 0.6 mm

### P1 GYS AUTO

**10 → 220 A** 230V 1~ PFC

with accessories :

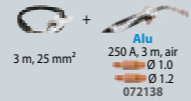

080584

### P1 GYS AUTO 208-240V

**10 → 220 A** 208>240V 1~ PFC

with accessories :

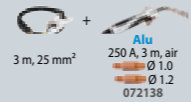

080911



1 x

P1 GYS AUTO 220 A • × 1

### P2 GYS AUTO

**10 → 220 A** 230V 1~ PFC

with accessories :



083134

### P2 GYS AUTO 208-240V

**10 → 220 A** 208>240V 1~ PFC

with accessories :



083189

### OPTION



Protection cover for 2-torch & 3-torch generator 052260



2 x

P2 GYS AUTO 220 A • × 2

### P3 GYS AUTO

**10 → 220 A** 230V 1~ PFC

with accessories :



080591

### P3 GYS AUTO 208-240V

**10 → 220 A** 208>240V 1~ PFC

with accessories :



080928

Cable support P2/P3 077300



3 x

P3 GYS AUTO 220 A • × 3

### OPTION

Protection cover for 2-torch & 3-torch generator 052260



MADE IN FRANCE	CE NORM. 60974/1	50/60 Hz	A	6m	min → max	A	200	300	Electronic Control	EN60974-1 (40°C)		Ø mm	Original equipment / Equipement d'origine / Originalausstattung / Equipamiento de fabrica			LxWxH cm / kg	Protected & compatible power generator (+/-15%)
										IA (60%)	X% (I2 max)		Alu Type B 1.0/1.2	Steel Type B 0.8/1.0	Steel Type B 0.6/0.8		
▪	P1 GYS AUTO	230V 1~	16		10 → 220	▪	▪	1 x	150	220 A @ 20 %	0.6 → 1.2	Alu Type B 1.0/1.2		78 x 45 x 80 / 45	9KVA		
▪	P1 GYS AUTO 208-240V	208 > 240V 1~	16	6m	10 → 220	▪	▪	1 x	150	220 A @ 20 %	0.6 → 1.2	Alu Type B 1.0/1.2		78 x 45 x 80 / -	9KVA		
▪	P2 GYS AUTO	230V 1~	16		10 → 220	▪	▪	2 x	150	220 A @ 20 %	0.6 → 1.2	Alu Type B 1.0/1.2	Steel Type B 0.8/1.0	86 x 63 x 93 / 58	9KVA		
▪	P2 GYS AUTO 208-240V	208 > 240V 1~	16	6m	10 → 220	▪	▪	2 x	150	220 A @ 20 %	0.6 → 1.2	Alu Type B 1.0/1.2	Steel Type B 0.8/1.0	86 x 63 x 93 / -	9KVA		
▪	P3 GYS AUTO	230V 1~	16		10 → 220	▪	-	3 x	150	220 A @ 20 %	0.6 → 1.2	Alu Type B 1.0/1.2	Steel Type B 0.8/1.0	86 x 63 x 93 / 62	9KVA		
▪	P3 GYS AUTO 208-240V	208 > 240V 1~	16	6m	10 → 220	▪	-	3 x	150	220 A @ 20 %	0.6 → 1.2	Alu Type B 1.0/1.2	Steel Type B 0.8/1.0	86 x 63 x 93 / -	9KVA		



# MIG/MAG DOUBLE PULSE SYNERGIC

Latest generation  
colour screen 5"  
800 x 480 (WVGA)



## ACCESSIBILITY

- 3 interface levels**
- EASY
  - EXPERT
  - ADVANCED
- 16 languages**
- French
  - English
  - German
  - Italian
  - Spanish
  - Portuguese
  - Czech
  - Polish
  - Dutch
  - Swedish
  - Russian
  - Chinese
  - Japanese
  - Vietnamese
  - Finnish
  - Turkish

### EASY



3 INTERFACE LEVELS

### ADVANCED



### EXPERT

Pre-gas / Hot Start / Upslope / Downslope / Crater filler / Post-gas



## 500+ JOBS can be saved



## TRACEABILITY



## PORTABILITY



## MODES

- DYNAMIC STANDARD
- PULSE
- PULSE IN PULSE
- MANUAL
- COLD PULSE**

## FULLY DIGITAL

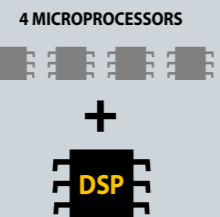

## 65+ SYNERGIES

Find all the synergies:  
Retrouvez toutes les synergies:  
Finde alle Synergien:



- STEEL
- Cu Si 3 / Cu Al 8
- ALU

## UPDATES

EASY USB UPDATE



USB key 16 Gb  
062344

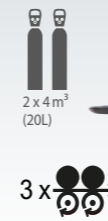
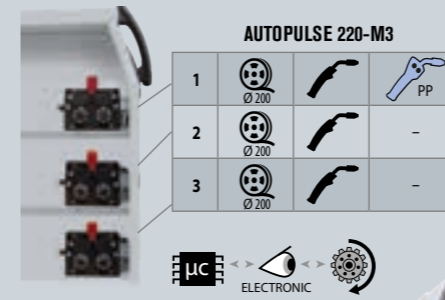

8 m

220 A • x 3

## PFC POWER FACTOR CORRECTION

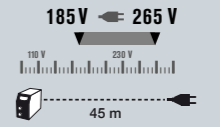

TESLA APPROVED

## AUTOPULSE 220-M3

10 220 A 230V 1~ PFC

- with accessories:
- 4 m, 35 mm<sup>2</sup> 043817
  - CuSi 150 A, 3 m, air Ø 1.0 072121
  - Steel 150 A, 3 m, air Ø 0.8 063754
  - Alu 250 A, 3 m, air Ø 1.0 072138
  - Alu 250 A, 3 m, air Ø 1.2 072138

036703

## AUTOPULSE 220-M3 208-240V

10 220 A 208>240V 1~ PFC

- with accessories:
- 4 m, 35 mm<sup>2</sup> 043817
  - CuSi 150 A, 3 m, air Ø 1.0 072121
  - Steel 150 A, 3 m, air Ø 0.8 063754
  - Alu 250 A, 3 m, air Ø 1.0 072138
  - Alu 250 A, 3 m, air Ø 1.2 072138

062481

## OPTIONS

### PUSH PULL TORCH 24 V

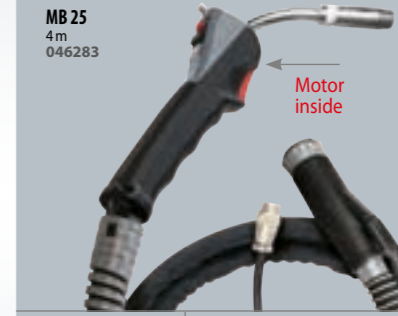

MB 25  
4 m  
046283

### Torch gas flow-meter

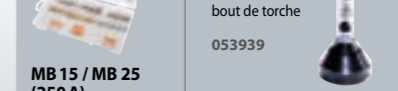

MB 15 / MB 25 (250 A)  
077089

### Protection cover



x5 (M6-0.6)  
x5 (M6-0.8)  
x5 (M6-1.0)  
x5 (Alu - M6-0.8)  
x5 (Alu - M6-1.0)  
x5 (Alu - M6-1.2)

053939  
052260

MADE IN FRANCE	50 / 60 Hz	A	Ø mm	min → max	SPOOLGUN	PUSH/PULL	Ø mm	Cooling system	Equipment d'origine Original equipment Originalausstattung Equipamiento de fabrica		EN60974-1 (40°C)	LxWxH cm / kg	Protected & compatible power generator (+/-15%)
									IA (60%)	X% (I2 max)			
<b>AUTOPULSE 220-M3</b>	230 V · 1 ~	8 m	16	0.6 → 1.2	10 → 220	-	OPTION	■	Air	ACIER : Type B 0.6 / 0.8 ACIER : Type B 0.8 / 1.0 ALU : Type B 1.0 / 1.2	150 220 A @ 20%	75 x 41 x 94 / 80	10 kVA
<b>AUTOPULSE 220-M3 208-240V</b>	208 > 240 V · 1 ~	8 m	16	0.6 → 1.2	10 → 220	-	OPTION	■	Air	ACIER : Type B 0.6 / 0.8 ACIER : Type B 0.8 / 1.0 ALU : Type B 1.0 / 1.2	150 220 A @ 20%	75 x 41 x 94 / 80	10 kVA



# MIG/MAG DOUBLE PULSE SYNERGIC



	AUTOPULSE 320-T1	AUTOPULSE 320-T3	AUTOPULSE 320-T3 208-240V
1	Ø 200 / 300	Ø 200	Ø 200
2	-	Ø 200	Ø 200
3	-	Ø 200	Ø 200

PP ELECTRONIC

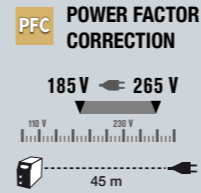

10 m³ (50L)

1 x

5 m

### AUTOPULSE 320-T1

**15 320 A** 400 V 3~

with accessories:

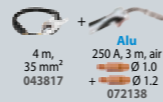

069831

### OPTIONS

#### PUSH PULL TORCH 24 V

MB 25  
4 m  
046283



Torch gas flow-meter  
- Débitmètre de bout de torche  
053939

MB 15 / MB 25 (250 A)  
077089

x5 (Mg-Ø 0.6)  
x5 (Mg-Ø 0.8)  
x5 (Mg-Ø 1.0)

x5 (Mg-Ø 0.8)  
x5 (Mg-Ø 1.0)  
x5 (Alu - Mg-Ø 1.0)  
x5 (Alu - Mg-Ø 1.2)

Protection cover  
- Housse de protection  
- Schutzhaube  
052260



2 x 4 m³ (20L)

3 x

5 m

### AUTOPULSE 320-T3

**15 320 A** 400 V 3~

with accessories:



067615

### AUTOPULSE 320-T3 208-240V

**15 320 A** 208>240 V 3~ PFC

with accessories:



036970

### OPTION

for AUTOPULSE 320-T3 (400 V) only

#### SPOOLGUN TORCH

##### Ideal Alu

Ø 0,8

4 m  
041486

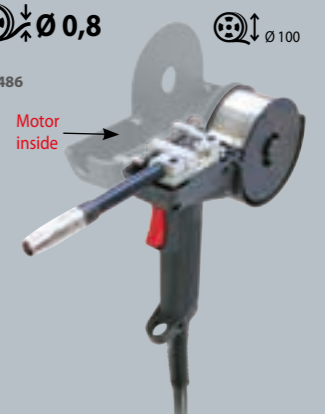

320 A • x 1

320 A • x 3

MADE IN FRANCE EN60974-1	50 / 60 Hz	A	Ø mm	min → max	SPOOLGUN	PUSH/PULL	Ø mm	Cooling system	Original equipment Equipement d'origine Originalausstattung Equipamiento de fabrica		EN60974-1 (40°C)	LxWxH cm / kg	Protected & compatible power generator (+/-15%)	
									ELECTRONIC CONTROL	IA (60%)				
<b>AUTOPULSE 320-T1</b>	400 V - 3~	5 m	16	0.6 → 1.2	15 → 320	-	OPTION	Air		ALU : Type B 1.0 / 1.2	260	320 A @ 35%	74 x 41 x 94 / 65.1	16 kVA

MADE IN FRANCE EN60974-1	50 / 60 Hz	A	Ø mm	min → max	SPOOLGUN	PUSH/PULL	Ø mm	Cooling system	Original equipment Equipement d'origine Originalausstattung Equipamiento de fabrica		EN60974-1 (40°C)	LxWxH cm / kg	Protected & compatible power generator (+/-15%)	
									ELECTRONIC CONTROL	IA (60%)				
<b>AUTOPULSE 320-T3</b>	400 V - 3~	5 m	16	0.6 → 1.2	15 → 320	OPTION	OPTION	Air		ACIER : Type C 0.8 / 1.0 mm ALU : Type C 1.0 / 1.2	260	320 A @ 35%	75 x 40 x 94 / 82	16 kVA
<b>AUTOPULSE 320-T3 208-240V</b>	208-240 V - 3~	5 m	25	0.6 → 1.2	15 → 320	-	OPTION	Air		ACIER : Type C 0.8 / 1.0 mm ALU : Type C 1.0 / 1.2	260	320 A @ 35%	74 x 41 x 95 / 82	16 kVA

# MANUAL TORCHES

- Torches manuelles - Brenner  
- Antorcha - Lastoort - Tocha

## CLASSIC



Flexible



## CLASSIC GRIP



CONFORT GRIP  
360°

## FUME EXTRACTION

Fume Extraction Torches - Torches aspirantes - Rauchgas-Absaugbrenner - Antorcha con aspiración de humos



Complete systems (p. 121)



## PUSH PULL

for AUTOPULSE



Motor inside

Speed

Arc length

Light weight

Select Adjust +/-

Rollers - Galets - Drahtführungsrollen - Rollen - Rodillos - Wielen - Roletes

0.6/0.8/1.0 046290  
0.8/1.0/1.2 038752

Connector Push Pull 10 pts 064393

## SPOOL GUN

Special CAR BODY REPAIR MACHINES



Ø100

Ideal for - Steel / Acier / Stahl - Stainless steel / Inox - Alu

4m

included 045699

## COMPLETE TORCHES

X % 40°C, ArCo <sub>2</sub>	Steel/Stainless steel - Acier / Inox - Stahl/Edelstahl						ALU - Aluminium - Aluminio					PUSH PULL AIR	SPOOL GUN AIR
	AIR			LIQUID			AIR			LIQUID			
	150 A	150 A	250 A	250 A	350 A	300 A	150 A	250 A	250 A	350 A	300 A		
	A1 + A2	A1 + A2	B1 + B2	B1 + B2	D1 + D2	C1 + C2	A1 + A2	B1 + B2	B1 + B2	D1 + D2	C1 + C2	B1 + B2	A1 + A2
	M6 Ø0.8	M6 Ø1.0	M6 Ø0.8	M6 Ø1.0	M8 Ø1.2	M6 Ø1.2	M6 Ø0.8	M6 Ø1.0	M6 Ø1.2	M8 Ø1.2	M6 Ø1.2	M6 Ø1.2	M6 Ø0.8
	3 m	3 m	3 m	3 m	4 m	3 m	3 m	3 m	3 m	3 m	3 m	4 m	4 m
	063754	072121	072145	072152	063792	040694	063761	063785	072138	063808	040748	046283	041486
	3 m				4 m	3 m	4 m						
	082151				063778	040687	043275	041462	040939				
	3 m				3 m	4 m							
	043251				040540	040557							

## Special MIG/MAG plier

- Pince spéciale MIG/MAG  
- Spezial MIG/MAG Zange

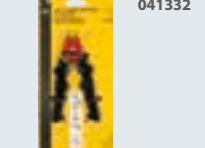

041332

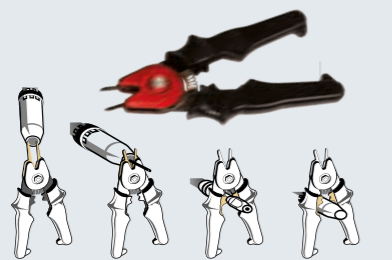

1) Clean 2) Cut 3&4) Prepare (contact tube & nozzle)

## Anti-spatter spray (without silicone)

- Spray protecteur sans silicone  
- Antihafspray (Ohne Silicon)

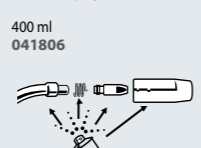

400 ml  
041806

## MIG torch stand with magnetic base

- Support torche magnétique

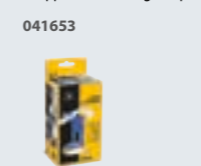

041653

# CONSUMABLES - Consommables

Gas nozzles - Buses - Düsen - Tubo - Nippel - Bicos

A	B	C	D	E
Conical nozzle - Buse conique - Konische Düse	Spot welding - Pointage - Punktöse	Nail welding - Soude clou - Nagelschweißdüse	Special No Gas (isolated) - Isolée spéciale Sans gaz	Conical nozzle - Buse conique - Konische Düse

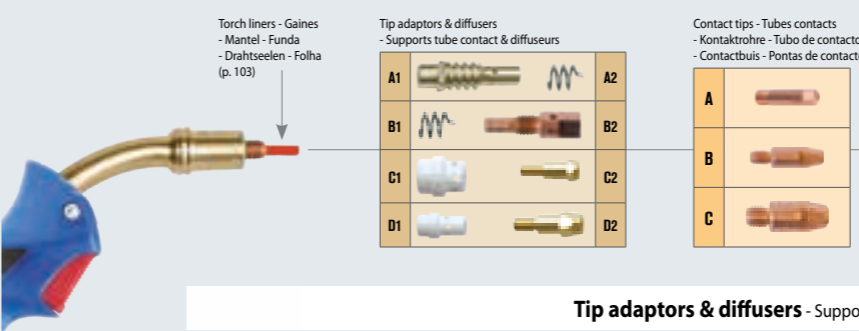

Torch liners - Gainses - Mantel - Funda - Drahtseelen - Folha (p. 103)

Tip adaptors & diffusers - Supports tube contact & diffuseurs	
A1	A2
B1	B2
C1	C2
D1	D2

Contact tips - Tubes contacts - Kontaktröhre - Tubo de contacto - Contactbuis - Pontas de contacto	
A	B
C	

## Tip adaptors & diffusers - Supports tube contact & diffuseurs

	Steel/Stainless steel - Acier / Inox - Stahl/Edelstahl				ALU - Aluminium - Aluminio				PUSH PULL		SPOOL GUN
	AIR		LIQUID		AIR		LIQUID		AIR		AIR
	150 A	250 A	350 A	300 A	150 A	250 A	350 A	300 A	150 A	250 A	150 A
	A1 (x5)	B1 (x5)	D1 (x3)	C1 (x3)	A1 (x5)	B1 (x5)	D1 (x3)	C1 (x3)	A1 (x5)	B1 (x5)	A1 (x5)
	042902	042995	043008	043589	042902	042995	043008	043589	042902	042995	042902
	A2 (x10)	B2 (x5)	D2 (x5)	C2 (x5)	A2 (x10)	B2 (x5)	D2 (x5)	C2 (x5)	A2 (x10)	B2 (x5)	A2 (x10)
	042988	042919	042926	043541	042988	042919	042926	043541	042988	042919	042988

## Contact tips - Tubes contacts - Kontaktröhre - Tubo de contacto - Contactbuis - Pontas de contacto

	150 A	250 A	350 A	300 A	150 A	250 A	350 A	300 A	150 A	250 A	150 A
Ø0.6	A (x10) 041905	A (x10) 041905	—	A (x10) 041905	—	—	—	—	—	—	—
Ø0.8	A (x10) 041912	B (x10) 041950	C (x10) 041790	B (x10) 041950	B (x10) 041059	A (x10) 041059	—	B (x10) 041059	B (x10) 041059	B (x10) 041059	B (x10) 041059
Ø1.0	A (x10) 041929	B (x10) 041967	C (x10) 419803	B (x10) 041967	B (x10) 041066	B (x10) 041066	C (x10) 419766	B (x10) 041066	B (x10) 041066	B (x10) 041066	B (x10) 041066
Ø1.2	A (x10) 040144	B (x10) 041974	C (x10) 419810	B (x10) 041974	B (x10) 041073	B (x10) 041073	C (x10) 419773	B (x10) 041073	B (x10) 041073	B (x10) 041073	B (x10) 041073
Ø1.4	—	—	C (x10) 419827	—	—	—	—	—	—	—	—
Ø1.6	—	—	C (x10) 419834	—	—	—	C (x10) 041080	—	—	—	—
Ø2.4	—	—	C (x10) 040533	—	—	—	—	—	—	—	—

## Gas nozzles - Buses - Düsen - Tubo - Nippel - Bicos

	150 A	250 A	350 A	300 A	150 A	250 A	350 A	300 A	150 A	250 A	150 A		
A	53 mm Ø12 (x3) 041875	57 mm Ø15 (x3) 041882	84 mm Ø16 (x3) 041783	63.5 mm Ø12 (x3) 043534	53 mm Ø12 (x3) 041875	53 mm Ø16 (x3) 046214	57 mm Ø15 (x3) 041882	84 mm Ø16 (x3) 041783	63.5 mm Ø12 (x3) 043534	63.5 mm Ø17 (x3) 046221	53 mm Ø12 (x3) 041875	57 mm Ø15 (x3) 041882	53 mm Ø12 (x3) 041875
B	53 mm (x1) 041851	—	—	—	—	—	—	—	—	—	—	—	—
C	53 mm (x1) 041523	—	—	—	—	—	—	—	—	—	—	—	—
D	(x1) 041868	—	—	—	—	—	—	—	—	—	—	—	—
E	(x1) 043084	(x1) 040571	(x1) 040588	—	—	—	—	—	—	—	—	—	—

## Boxes

- Coffrets - Verschleißteilebox  
- Cajas - Kistjes - Estojos

	x 3		x 5		M6-Ø0.6 x 5 M6-Ø0.8 x 5 Alu-M6-Ø0.8 x 5		x 3	=	<b>MB 15 (150 A)</b> 041226
	M6-Ø0.6 x 5 M6-Ø0.8 x 5 Alu-M6-Ø1.0 x 5		M6-Ø0.8 x 5 M6-Ø1.0 x 5 Alu-M6-Ø1.0 x 5 Alu-M6-Ø1.2 x 5		—		—	=	<b>MB 15 / MB 25</b> 077089
	x 5		x 3		M6-Ø0.8 x 5 M6-Ø1.0 x 5 Alu-M6-Ø1.0 x 5		x 3	=	<b>MB 25 (250 A)</b> 041233
	x 2		x 3		M6-Ø1.0 x 5 M6-Ø1.2 x 5 Alu-M6-Ø1.0 x 5 Alu-M6-Ø1.2 x 5		x 2	=	<b>MB 36 (350 A)</b> 041417



# CONSUMABLES - Consommables

## TORCH LINERS - Gainses - Mantel - Funda - Drahtseelen - Folha

STEEL - Acier - Stahl - Acero - Staal - Aço			
Ø 0.6 / 0.8	3 m	041592	
	4 m	041837	
Ø 1.0 / 1.2	3 m	041608	
	4 m	041844	
	5 m	062276	
Ø 1.2 / 1.6	3 m	418417	
	4 m	418424	
Ø 1.6 / 2.4	4 m	040526	
	5 m	062290	

TEFLON			
Ø 0.6 / 0.8	3 m	041578	
	4 m	044050	
Ø 1.0 / 1.2	3 m	041585	
	4 m	044067	
	8 m	038677	
Ø 1.2 / 1.6	4 m	044074	



Guide gaine téflon pour motodévidoir 079601

CARBON			
Ø 0.6 / 0.8	4 m	039834	
	5 m	062306	
Ø 1.0 / 1.2	4 m	039827	
	5 m	062313	
Ø 1.2 / 1.6	4 m	039810	

### PUSH PULL TORCH

Ø 1.0 / 1.2	8 m	038172
-------------	-----	--------

## ROLLERS - Galets - Vorschubrollen - Rollen - Rodillos - Wielen - Roletes

### TYPE A

For : Carmig



Steel, Stainless steel - Acier, Inox	Ø 0.6 / 0.8	x1	042339
	Ø 0.8 / 1.0	x1	041189
Alu	Ø 0.8 / 1.0	x1	041196
Cored wire - Fil fourré	Ø 0.8 / 0.9	x1	046856
	Ø 0.9 / 1.2	x1	042346



### TYPE B

For : Autopulse 220, Autopulse 320-T1, M1 GYS Auto, M3 GYS auto, T1 GYS Auto, T3 GYS Auto, E1/E2/E3 GYS Auto



Steel, Stainless steel - Acier, Inox	Ø 0.6 / 0.8	x1	042087
		x2	042353
	Ø 0.8 / 1.0	x1	042100
		x2	042360
	Ø 1.0 / 1.2	x1	042179
		x2	046849
Alu	Ø 1.2 / 1.6	x2	042384
	Ø 0.8 / 1.0	x1	042155
		x2	042377
	Ø 1.0 / 1.2	x1	042186
		x2	040915
	Ø 1.2 / 1.6	x2	042391
Cored wire - Fil fourré	Ø 0.9 / 1.2	x1	042131
		x2	042407

### TYPE C

For : Neopulse - Autopulse 320-T3



Steel, Stainless steel - Acier, Inox	Ø 0.6 / 0.8	x2	041738
	Ø 0.8 / 1.0	x2	042094
	Ø 1.0 / 1.2	x2	042117
	Ø 1.2 / 1.4	x2	039780
	Ø 1.2 / 1.6	x2	041752
	Ø 0.8 / 1.0	x2	042148
Alu	Ø 1.0 / 1.2	x2	042162
	Ø 1.2 / 1.6	x2	041776
Cored wire - Fil fourré	Ø 0.9 / 1.2	x2	042124

## NO GAS WELDING KIT Ø 0.9 - Kit soudage sans gaz Ø 0.9

041240

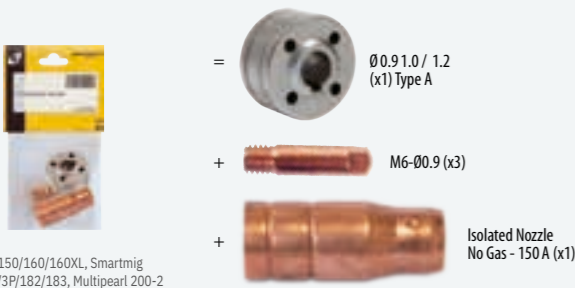

For : Easymig 150/160/160XL Smartmig 142/152/162/3P/182/183, Multipearl 200-2

## PRESSUR-REGULATORS - Manomètres-débitmètres - Druckminderer



15 l/min

(FR) 041998  
(UK) 040274  
(NL) 040267  
(IT) 038691

30 l/min

(FR) 041622  
(UK) 041646  
(DE) 041219  
(NL) 041615  
(IT) 038707

## GAS CONNECTORS - Raccords gaz - Gasanschlüsse



x2 045712

Ø8 Ø7 x1 046245

x1 067936

Tuyau caoutchouc - Rubber hose  
Ø 6.3 X 13 (EN ISO 3821)  
1.5 m 066670  
4 m 046269  
> x m 046276



Optima Pro  
30 l/min

(FR) 043619  
(UK) 043626  
(DE) 043633  
(NL) 043640



Torch gas flow-meter  
- Débitmètre de bout de torche  
053939

# WELDING WIRE REELS

- Bobines de fil - Drahtrollen - Rollos de hilo - Draadbobbijn - Bobines de fio

100 mm

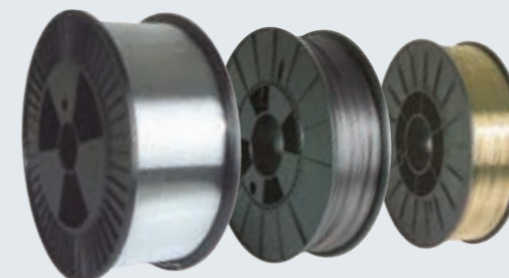

ECO  
Ecological wire reel - Bobine écologique

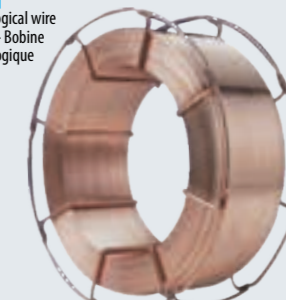

## STEEL - Acier - Stahl - Acero - Staal - Aço

### SG2

Norms : AWS 5.18 : ER 70S-6 ; EN ISO 14341-A : G46 4MG3S1 ; DIN 8559 : SG2

100 mm 0.9 kg	Ø 0.6	086593
	Ø 0.8	086609
200 mm 5 kg	Ø 0.6	086111
	Ø 0.8	086128
	Ø 1.0	086135
300 mm 15 kg	Ø 0.6	086166
	Ø 0.8	086227
	Ø 0.8 ECO	086272
EXCELLIUM 15 kg	Ø 1.0	086234
	Ø 1.0 ECO	086289
	Ø 1.2	086241
EXCELLIUM 15 kg	Ø 1.2 ECO	086296
	Ø 1.0 ECO	086302
	Ø 1.2 ECO	086319

### SG1

Norms : AWS 5.18 : ER 70S-3 ; EN ISO 14341-A : G42 2MG2S1 ; DIN 8559 : SG1

200 mm	Ø 0.6	086418
5 kg	Ø 0.8	086401

### CrMo2Si

Norms : AWS 5.28 : ER 90S-B3 ; EN ISO 2195L-A : Cr CrMo2Si

300 mm	Ø 0.8	086258
--------	-------	--------

### UHSS

Norms : AWS ASME SFA-5.28 : ER 120 S-G ; EN ISO 12534 : G Mn4Ni2, 5CrMo

200 mm	Ø 0.8	086203
--------	-------	--------

### Hardfacing - Rechargement Acier 60 HRC

Norms : EN 14700 : TZ Fe 2 ; DIN 8555 : MSG 6-CF-60

300 mm	Ø 1.2 ECO	086173
--------	-----------	--------

## Cored wire - Fil fourré - Fülldraht - Hilo tubular

Norms : AWS 5.20 : E71T-G5 ; EN ISO 17632-A T42 Z W N 1 H15

100 mm	Ø 0.6	086425
0.9 kg	Ø 0.9	086104

200 mm	Ø 0.9	086265
--------	-------	--------

4.5 kg	Ø 1.0	086623
--------	-------	--------

	Ø 1.2	086630
--	-------	--------

300 mm	Ø 1.0	086388
--------	-------	--------

15 kg	Ø 1.2	086395
-------	-------	--------

### Galva (G2Ti)

Norms : AWS 5.18 : ER 70S-2 ; EN ISO 14341-A : G42 2 M G2Ti ; DIN 8559 : SG2

200 mm	Ø 0.6	086760
--------	-------	--------

5 kg	Ø 0.8	086777
------	-------	--------

## BRAZING - Brasage

### CuAl8 HLE - UHTS (Boron Steel)

Norms : AWS 5.7 : ER CuAl-A1 ; EN ISO 14640 : S Cu 6100 ; DIN 1733 : SG-CuAl8

200 mm	Ø 0.8	077409
2 kg	Ø 0.8	086661
200 mm	Ø 1.0	086197
5 kg	Ø 1.0	086180

### CuSi3 HLE - UHTS (Boron Steel)

Norms : AWS 5.7 : ER CuSi-A ; EN ISO 14640 : S Cu 6560 ; DIN 1733 : SG-CuSi3

100 mm	Ø 0.8	086692
--------	-------	--------

200 mm	Ø 0.8	077393
--------	-------	--------

200 mm	Ø 0.8	086647
--------	-------	--------

5 kg	Ø 1.0	086654
------	-------	--------

200 mm	Ø 0.8	086210
--------	-------	--------

EXCELLIUM 5 kg	Ø 0.8	086210
-------------------	-------	--------

## STAINLESS STEEL - Inox - Edelstahl

### CrNi (316LSi)

Norms : AWS 5.9 : ER 316L Si ; EN ISO 14343-A : G19 12 3 L Si ; DIN 8556 : SG X2 CrNiMo 19 12

200 mm	Ø 0.8	086326
--------	-------	--------

5 kg	Ø 1.0	086364
------	-------	--------

300 mm	Ø 1.0	086371
--------	-------	--------

### CrNi (308LSi)

Norms : AWS 5.9 : ER 308L Si ; EN ISO 14343-A : G19 9 L Si ; DIN 8556 : SG X2CrNi 19 9

100 mm	Ø 0.8	086616
--------	-------	--------

200 mm	Ø 0.8	086579
--------	-------	--------

5 kg	Ø 1.0	086340
------	-------	--------

300 mm	Ø 1.0	086357
--------	-------	--------

## ALUMINIUM

### AlSi5

Norms : AWS 5.10 : ER 4043 ; EN ISO 18273 : S Al 4043-A ; DIN 1732 : SG-AlSi5

100 mm	Ø 0.8	086685
--------	-------	--------

200 mm	Ø 1.0	086142
--------	-------	--------

2 kg	Ø 1.2	086159
------	-------	--------

### AlSi12

Norms : AWS 5.10 : ER 4047 ; EN ISO 18273 : S Al 4047 ; DIN 1732 : SG-AlSi12

100 mm	Ø 0.8	086678
--------	-------	--------

200 mm	Ø 0.8	077140
--------	-------	--------

2 kg	Ø 1.0	086067
------	-------	--------

	Ø 1.2	086074
--	-------	--------

300 mm	Ø 1.2	086043
--------	-------	--------

### AlSi10Cu4

Norms : AWS 5.10 : ER 4145 ; EN ISO 18273 : S Al 41

200 mm	Ø 1.2	073432
--------	-------	--------

2 kg	Ø 1.2	073432
------	-------	--------

### AlMg5

Norms : AWS 5.10 : ER 5356 ; EN ISO 18273 : S Al 5356 ; DIN 1732 : SG-AlMg5

100 mm	Ø 0.8	086548
--------	-------	--------

200 mm	Ø 0.8	086555
--------	-------	--------

2 kg	Ø 1.0	086562
------	-------	--------

300 mm	Ø 1.0	086524
--------	-------	--------

7 kg	Ø 1.2	086531
------	-------	--------

EXCELLIUM 7 kg	Ø 1.0 ECO	086487
-------------------	-----------	--------

	Ø 1.2 ECO	086494
--	-----------	--------

### AlMg2.7Mn

Norms : AWS 5.10 : ER 5554 ; EN ISO 18273 : S Al 5554 ; DIN 1732 : SG-AlMg

200 mm	Ø 1.2	086517
--------	-------	--------

2 kg	Ø 1.2	086517
------	-------	--------

300 mm	Ø 1.2	086500
--------	-------	--------

7 kg	Ø 1.2	086500
------	-------	--------

### Thickness measurement tools (x3)

- Jauges d'épaisseur (x3)  
- Dickenessgeräte (x3)  
071414

0.6 > 8 mm







# PLASMA CUTTING

EASYCUT K	97
EASYCUT	98
CUTTER	99



# PLASMA

COMPRESSOR INSIDE • 1~



**EASYCUT K25**

230 V • 1 ~ 25 A Fe 8 mm  
Al/CrNi 6 mm

P400 COMPRESSOR

TPT25, 4 m 068087 2 m, 10 mm<sup>2</sup>  
068063

Youtube

COMPRESSOR COMPRESSOR INSIDE

ULTRA LIGHT & COMPACT

INTEGRATED AIR FILTER + AUTOMATIC DRAIN

PFC EN 61000-3-12 POWER FACTOR CORRECTION

Youtube

**EASYCUT K35 PFC**

230 V • 1 ~ 35 A Fe 15 mm  
Al/CrNi 10 mm

P400 PFC AD COMPRESSOR

TPT35, 4 m 080775 2 m, 10 mm<sup>2</sup>  
080768

TPT35, 4 m 2 m, 10 mm<sup>2</sup> Box TPT35 080782 UNIVERSAL 800 051331  
080805

### OPTIONS

Consummables	Compas 040205	PLASMA 600 040298	Universal 800 051331																																										
<table border="1"> <tr> <td></td> <td></td> <td></td> <td></td> <td>Boxes - Coffrets</td> </tr> <tr> <td>x4 040236</td> <td>x10 040212</td> <td>x2 040175</td> <td>x10 040168</td> <td>039971</td> </tr> <tr> <td>x1</td> <td>x1</td> <td>x1</td> <td>x1</td> <td></td> </tr> <tr> <td></td> <td></td> <td></td> <td></td> <td>080782</td> </tr> <tr> <td>x4 040182</td> <td>x10 080799</td> <td>x2 040175</td> <td>x10 040168</td> <td></td> </tr> <tr> <td>x1</td> <td>x1</td> <td>x1</td> <td>x1</td> <td></td> </tr> </table>					Boxes - Coffrets	x4 040236	x10 040212	x2 040175	x10 040168	039971	x1	x1	x1	x1						080782	x4 040182	x10 080799	x2 040175	x10 040168		x1	x1	x1	x1		<table border="1"> <tr> <td></td> <td></td> </tr> <tr> <td>x1 040199</td> <td></td> </tr> </table>			x1 040199		<table border="1"> <tr> <td></td> </tr> <tr> <td>PLASMA 600 040298</td> </tr> <tr> <td>↓ 39 x 58 x 62 cm / 8.2 kg</td> </tr> <tr> <td>⊗ 63 x 30 x 11 cm / 8.8 kg</td> </tr> </table>		PLASMA 600 040298	↓ 39 x 58 x 62 cm / 8.2 kg	⊗ 63 x 30 x 11 cm / 8.8 kg	<table border="1"> <tr> <td></td> </tr> <tr> <td>Universal 800 051331</td> </tr> <tr> <td>↓ 48 x 62 x 81 cm / 17.6 kg</td> </tr> <tr> <td>⊗ 81 x 52 x 15 cm / 18.1 kg</td> </tr> </table>		Universal 800 051331	↓ 48 x 62 x 81 cm / 17.6 kg	⊗ 81 x 52 x 15 cm / 18.1 kg
				Boxes - Coffrets																																									
x4 040236	x10 040212	x2 040175	x10 040168	039971																																									
x1	x1	x1	x1																																										
				080782																																									
x4 040182	x10 080799	x2 040175	x10 040168																																										
x1	x1	x1	x1																																										
x1 040199																																													
PLASMA 600 040298																																													
↓ 39 x 58 x 62 cm / 8.2 kg																																													
⊗ 63 x 30 x 11 cm / 8.8 kg																																													
Universal 800 051331																																													
↓ 48 x 62 x 81 cm / 17.6 kg																																													
⊗ 81 x 52 x 15 cm / 18.1 kg																																													

MADE IN FRANCE CE NORM EN60974-1	50/60 Hz	I <sub>2</sub>	mm				INTEGRATED TECHNOLOGY				AIR SYSTEM			EN 60974-1 (40°C)			LxWxH cm / kg	Protected & compatible power generator (+/-15%)			
			Coupe max Severance cut	Coupe propre Clean cut	Perçage Piercing	P400	PFC	AD	IP23	COMPRESSOR	min	ideal	max	I 60%	X% I2,max	100%					
<b>EASYCUT K25</b>	230V 1~	16	10 → 25	8	6	6	4	4	2	■	—	—	—	■	included	15 A	35%	—	53 x 31 x 48 / 19	6.5 kW	7.5 kVA
<b>EASYCUT K35 PFC</b>	230V 1~	16	10 → 35	15	10	10	8	6	5	■	■	■	■	■	included	26 A	30%	—	45 x 26 x 36 / 27	8 kW	10 kVA



# PLASMA

1~

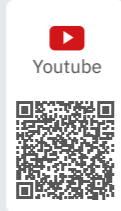

Plasma torch  
TPT 25, 4m  
068087

Plasma torch  
TPT 35, 4m  
080775

Plasma torch  
TPT 40, 4m  
060753

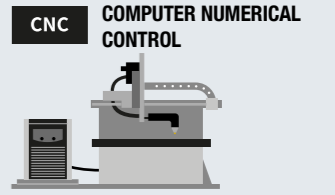
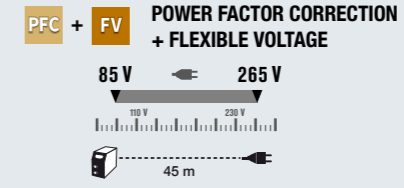
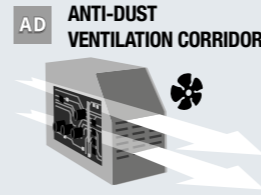

DIGITAL (PRESSURE SENSOR)

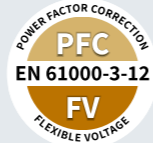

IDEAL CARBONY REPAIR



DIGITAL (PRESSURE SENSOR)

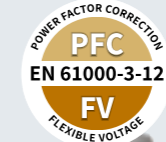

DIGITAL (PRESSURE SENSOR)



**EASycut 25**

230 V • 1 ~ 25 A Fe 8 mm  
Al/CrNi 6 mm

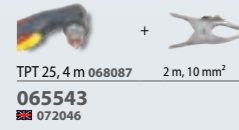

TPT 25, 4 m 068087 2 m, 10 mm<sup>2</sup>  
065543  
072046

**EASycut 30 FV**

110 → 230 V • 1 ~ 30 A Fe 15 mm  
Al/CrNi 10 mm

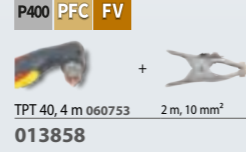

TPT 30, 4 m 060753 2 m, 10 mm<sup>2</sup>  
013858

**EASycut 40**

230 V • 1 ~ 40 A Fe 18 mm  
Al/CrNi 15 mm

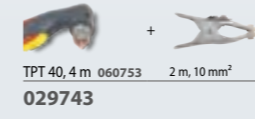

TPT 40, 4 m 060753 2 m, 10 mm<sup>2</sup>  
029743

**Cutter 45 CT**

110 → 230 V • 1 ~ 45 A Fe 30 mm  
Al/CrNi 20 mm



MT 70, 6 m 2 m, 10 mm<sup>2</sup> Box 20-50A 061613  
062962

OPTIONS



**COMPAS**  
for TPT 40, TPT 25, TPT 35,  
MT 25K / MT 35K  
x1 040199

Consumables	MT25K	TPT25	MT35K	TPT35	TPT40
	x4 040182	x4 040236	x4 040229	x4 040182	x4 040236
	x10 040151	x10 040212	x10 040212	x10 080799	x10 040212
	x2 040175	x2 040175	x2 040175	x2 040175	x2 040175
	x10 040168	x10 040168	x10 040168	x10 040168	x10 040168
Boxes - Coffrets	039971	070721	039964	080782	039957



**Trolley - Chariot**

PLASMA 600 040298  
↓ 39 x 58 x 62 cm / 8.2 kg

Universal 800 039568  
↓ 48 x 62 x 81 cm / 17.6 kg

Jobsite XL 039568  
↓ 60 x 59 x 115 cm / 18.4 kg



Compressed air cleaning filter for Plasma Cutter 40  
- Filtre déshumidificateur spécial Plasma 039728

Filter cartridge - Cartouche pour filtre 039735

CE NORMA EN60974-1	EASycut	50/60 Hz	I <sub>2</sub>	mm			INTEGRATED TECHNOLOGY						AIR SYSTEM			EN 60974-1 (40°C)		LxWxH cm / kg	Protected & compatible power generator (+/-15%)							
				Coupe max Severance cut	Coupe propre Clean cut	Perçage Piercing	P400	PFC	FV	GRID CUT	AD	IP23	CNC	min	ideal	max	I 60%			X% I2 max	100%					
MADE IN GYS CHINA	<b>EASycut 25</b>	230V 1~	16	10 → 25	8	6	6	4	4	3	—	—	—	—	—	—	2.5 bar	4.5 bar 115 L/min	6.5 bar	15 A	30%	10 A	45 x 25 x 35 / 9.7	—	—	
MADE IN FRANCE	<b>EASycut 30 FV</b>	230V 1~ 110V 1~	16 32	10 → 30 10 → 30	15	10	10	8	6	5	■	■	■	—	—	—	2.5 bar	5 bar 115 L/min	9 bar	23 A 19 A	30% 25%	20 A 15 A	51 x 29 x 37 / 14.3	6.5 kW	6 kVA	
MADE IN GYS CHINA	<b>EASycut 40</b>	230V 1~	16	10 → 40	20	15	15	10	8	6	—	—	—	—	—	—	2.5 bar	4.5 bar 115 L/min	6.5 bar	10 A	20%	—	45 x 25 x 35 / 11.5	—	—	
MADE IN FRANCE	<b>Cutter 45CT</b>	<i>TPT 40</i>	16	15 → 45	20	15	15	10	8	6	—	—	—	—	—	—	5 bar	5.2 bar 115 L/min	7 bar	41 A	50%	32 A	51 x 31 x 47 / 16.4	10.5 kW	8 kVA	
		<i>MT 70</i>	32	15 → 30	15	10	10	8	—	—	—	■	■	■	■	■	analogic	5 bar	5.2 bar 115 L/min	7 bar	21 A	25%				17 A
		<i>MT 70</i>	32	15 → 45	30	20	25	15	12	10	—	—	—	—	—	—	—	5 bar	5.2 bar 185 L/min	7 bar	41 A	50%				32 A





**GYS**

INVEST IN THE FUTURE



# INDUCTION HEATING

1 200 - 22 000 kW

GYS DUCTION 102

COMBI DUCTION 103

POWER DUCTION 104

ACCESSORIES & CONSUMABLES 108



# INDUCTION HEATING

CAR BODY

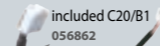
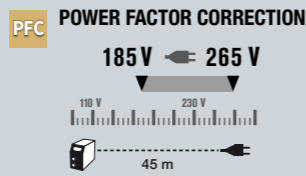

**INCLUDED COMBIDUCTION**

Glass - Décapage - Entfernen 053373

Decal - Décollage - Entkleben 053359

**OPTIONS**

	5 inductors 054783	12 inductors 085527
Spiral inductor - Inducteur spirale - Spiralinduktor	NEW	
2.5 m	1.2 kW	
800 mm 054813		
800 mm 054868		
<b>SIDE</b>		
Ø 18 mm ⊙ ≤ M8 054806		
Ø 24 mm ⊙ ≤ M12 054790		
Ø 30 mm ⊙ ≤ M16 055469		
<b>SIDE</b>		
Ø 21 mm ⊙ ≤ M10 079953		
Ø 27 mm ⊙ ≤ M14 079960		
Ø 18 mm ⊙ ≤ M8 079977		
Ø 21 mm ⊙ ≤ M10 079984		
Ø 24 mm ⊙ ≤ M12 079991		
Ø 27 mm ⊙ ≤ M14 080003		
Ø 30 mm ⊙ ≤ M16 080010		
<b>FRONT</b>		
Ø 24 mm ⊙ ≤ M12 080003		
Ø 27 mm ⊙ ≤ M14 080010		
Ø 30 mm ⊙ ≤ M16 080010		

PDR - Paintless Dent Repair - Débosselage sans peinture - Lackschadenfreies Ausbeulen 054776

Licensed by BETAG innovation

Freezer spray - Spray refroidisseur -50 °C 400 ml (x 12) 048898

Adhesive for logo (x10) 051492

**GYSDUCTION AUTO** 2400 W 230V • 1~ PFC AIR

**GYSDUCTION AUTO 120V** 2400 W 120V • 1~ PFC AIR

**COMBIDUCTION AUTO 50LG** 5200 W 230V • 1~ PFC LIQUID 065901

**COMBIDUCTION AUTO 50LG 208-240V** 5200 W 208-240V • 1~ PFC LIQUID 084872

**CONSUMABLES**

for [cable] Protection (x5) + Colle - Stick 053854

for [cable] Protection (x1) + Colle - Stick 059108

for [cable] Protection (x10) + Colle - Stick 053847

EN-60 335/1	MADE IN FRANCE	Cable L (m)	Freq.	Tech.	PFC	Liquid Cooling	Inductor	Heating			LxWxH cm / kg	LxWxH cm / kg	Protected & compatible power generator (+/-15%)	
								Heating	Heating	Heating				
<b>GYSDUCTION AUTO</b>	230V, 1~, 50/60 Hz	16 mini	2400	35+100			2	2.5	M10 → 1 s	2 mm → 5 s	Ø8 → 10 s	37 x 21 x 37 / 7.5	52 x 30 x 37 / 12.9	3 kW
<b>GYSDUCTION AUTO 120V</b>	120-240V, 1~, 50/60 Hz	20 mini	2400	35+100			2	2.5	M10 → 1 s	2 mm → 5 s	Ø8 → 10 s	37 x 21 x 37 / 7.5	52 x 30 x 37 / 12.9	3 kW
<b>COMBIDUCTION AUTO 50LG</b>	230V, 1~, 50/60 Hz	25 mini	5200	20+80		71	8	3	M14 → 1 s	2 mm → 3 s 4 mm → 5 s	Ø10 → 10 s	46 x 43 x 75 / 60	79 x 58 x 60 / 72	6 kW
<b>COMBIDUCTION AUTO 50LG 208-240 V</b>	208-240V, 1~, 50/60 Hz	25 mini	5200	20+80		71	8	3	M14 → 1 s	2 mm → 3 s 4 mm → 5 s	Ø10 → 10 s	46 x 43 x 75 / 60	79 x 58 x 60 / 74	6 kW



INDUCTION HEATING

1.2 → 5.2 kW

MAINTENANCE / MECHANIC / INDUSTRY

	10R	10R PRO
POWERDUCTION 10R	✓	✓
Flexible 800 mm   054813	✓	✓
Straight 800 mm   054868	✓	✓
<b>SIDE</b>		
Ø 18 mm ⊙ ≤ M8   054806	✓	✓
Ø 21 mm ⊙ ≤ M10   079953	✓	✓
Ø 24 mm ⊙ ≤ M12   054790	✓	✓
Ø 27 mm ⊙ ≤ M14   079960	✓	✓
Ø 30 mm ⊙ ≤ M16   055469	✓	✓
<b>FRONT</b>		
Ø 18 mm ⊙ ≤ M8   079977	✓	✓
Ø 21 mm ⊙ ≤ M10   079984	✓	✓
Ø 24 mm ⊙ ≤ M12   079991	✓	✓
Ø 27 mm ⊙ ≤ M14   080003	✓	✓
Ø 30 mm ⊙ ≤ M16   080010	✓	✓



	included	37LG S90	37LG S180/B3W
S90   058927	✓	✓	—
S180/B3W   067899	—	—	✓



1 200 W | 230V • 1~ | AIR

**POWERDUCTION 10R**  
(5 inductors)  
062504  
068643  
080966

**POWERDUCTION 10R PRO**  
(12 inductors)  
080195  
080300

**POWERDUCTION 37LG (S90)**  
**3 700 W** | 230V • 1~  
\* LIQUID  
056992  
080195  
072510  
080959

**POWERDUCTION 37LG (S180/B3W)**  
**3 700 W** | 230V • 1~  
\* LIQUID  
083387  
083394

**POWERDUCTION 37LG (S90) 208-240V**  
**3 700 W** | 208-240 V • 1~  
\* LIQUID  
084865

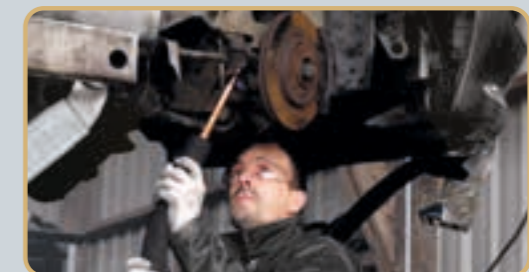
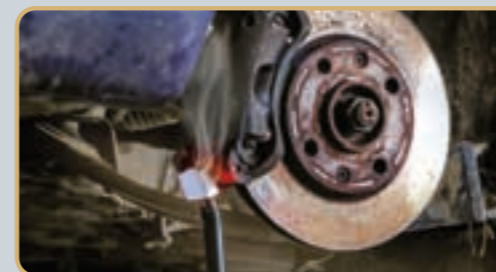
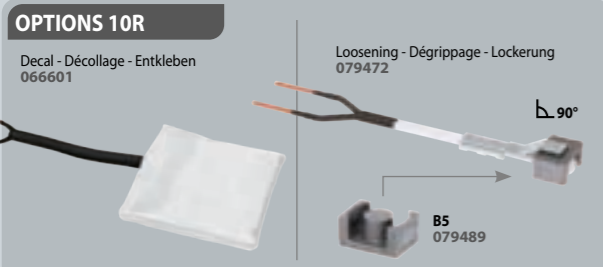
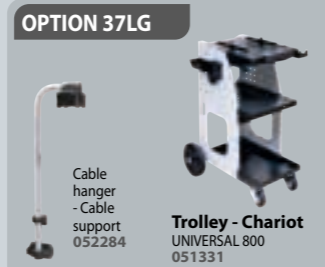

	included	39LG C20/B1	39LG S90
C20/B1   056862	✓	✓	—
285   064485	—	—	✓
S90   058927	—	—	✓

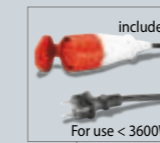

READY TO USE  
Liquid included

READY TO USE  
Liquid included

Option  
Protection cover  
- Housses de protection  
- Schutzhaube  
062733

**POWERDUCTION 39LG (C20/B1)**  
**3 700 W** | 230V • 1~  
PFC \* LIQUID  
058583

**POWERDUCTION 39LG (S90)**  
**3 700 W** | 230V • 1~  
PFC \* LIQUID  
080027  
087620 NEW

**POWERDUCTION 50LG**  
**5 200 W** | 230V • 1~  
PFC \* LIQUID  
055599

MADE IN FRANCE	A	W	kHz	P400	PFC	Liquid Cooling	Cable L (m)		Heating			Protected & compatible power generator (+/-1.8%)	L × W × H cm / kg	L × W × H cm / kg
							Inductor	Inductor	Heating	Heating	Heating			
<b>POWERDUCTION 10R / 10R PRO</b>	230V, 1~ 50/60 Hz	10 mini	1200	45+80	—	—	2	1.5	M10 → 1 s	2 mm → 5 s	Ø8 → 10 s	1.5 kW	062504 - 21 x 10 x 15 / 3.3 080195 - 21 x 17 x 14.5 / 3.3	062504 - 41.5 x 17 x 36.5 / 5.5 080195 - 46 x 20.5 x 38 / 5.4
<b>POWERDUCTION 37LG (S90) / (S180/B3W)</b>	230V, 1~ 50/60 Hz	16 mini	3700	15+30	—	■ 1.5l	2	2	M10 → 1 s	2 mm → 5 s	Ø10 → 15 s	4 kW	56 × 26 × 29 / 13	60 × 34 × 33 / 14.5
<b>POWERDUCTION 37LG (S90) 208-240V</b>	208-240V, 1~ 50/60 Hz	20 mini	3700	15+30	—	■ 1.5l	2	2	M10 → 1 s	2 mm → 5 s	Ø10 → 15 s	4 kW	56 × 26 × 29 / 14	60 × 34 × 33 / 15.5
<b>POWERDUCTION 39LG (C20/B1) / (S90)</b>	230V, 1~ 50/60 Hz	16 mini	3700	20+60	■	■ 7l	6	3	M12 → 1 s	2 mm → 5 s	Ø10 → 15 s	4 kW	46 × 36 × 70 / 46.5	81 × 38 × 59 / 52.5
<b>POWERDUCTION 50LG</b>	230V, 1~ 50/60 Hz	25 mini	5200	20+60	■	■ 7l	8	3	M14 → 1 s	2 mm → 3 s 4 mm → 5 s	Ø10 → 10 s	6 kW	46 × 43 × 75 / 58	80 × 60 × 60 / 71



# INDUCTION HEATING 11 → 22 kW

### OPTIONS

Skate  
037717



↓ 8 kg  
⊗ 71 x 35 x 10 cm / 8.3 kg

DIABLE JOBSITE XL  
039568



↓ 18.3 kg  
⊗ 66 x 47 x 20 cm / 19.5 kg

included adapter  
32L + L20/B4  
064515 + 067882

**NEW**  
04/2025



4 m

READY TO USE  
Liquid included

POWERDUCTION  
110LG COMPACT (L20/B4)

11 000 W 400 V • 3~

\* LIQUID

087637

### Included

Removable handle  
- Poignée de lance  
- Abnehmbarer Griff  
for POWERDUCTION  
110 - 160 - 220 LG  
068599



	included	110LG L90	110LG L20/B4
32L	064515	✓	✓
L90	059788	✓	—
L20/B4	067882	—	✓



4 m

READY TO USE  
Liquid included

POWERDUCTION  
110LG (L90)

11 000 W 400 V • 3~

\* LIQUID

058590

POWERDUCTION  
110LG (L20/B4)

11 000 W 400 V • 3~

\* LIQUID

083400

POWERDUCTION  
110LG (L90) 208-240V

11 000 W 208-240 V • 3~

\* LIQUID

065246

### OPTION

Powerduction  
160/220 LG over  
hanging arm-pulley  
- Equilibreur Powerduction  
160/220 LG

079441



	included	160LG L90	160LG L20/B4
32L	064515	✓	✓
L90	059788	✓	—
L20/B4	067882	—	✓



6 m

6 m  
or  
10 m

included adapter  
32L + L20/B4  
064515 + 067882

READY TO USE  
Liquid included

READY TO USE  
Liquid included

POWERDUCTION  
160LG (L90)

16 000 W 400 V • 3~

\* LIQUID

057814

POWERDUCTION  
160LG (L20/B4)

16 000 W 400 V • 3~

\* LIQUID

083417

POWERDUCTION  
160LG (L20/B4) 208-240 V

16 000 W 208-240 V • 3~

\* LIQUID

065253

POWERDUCTION  
220LG

22 000 W 400 V • 3~

\* LIQUID

6 m cable: 066861  
10 m cable: 074576

### t° POWER HEAT CONTROLLER

t° CONTROL  
80>350°C (210>660°F)



Compatibility  
POWERDUCTION  
110-160-220

POWER HEAT  
CONTROLLER  
061644

Included  
T° sensors  
thermocouple type K  
x2

### OPTION

PYROMETER IR  
064119



for  
inductor L90

### OPTIONS



Protection cover  
- Housse de protection  
- Schutzhaube  
for POWERDUCTION  
160 - 220 LG  
062733



Cooling  
liquid

2L 082212  
5L 062511  
10L 052246



Protection cover  
- Housse de protection  
- Schutzhaube  
for POWERDUCTION  
160 - 220 LG  
050853



055490

MADE IN FRANCE	Cable L (m)	Freq.	Liquid Cooling	Inductor	Heating		LxWxH cm / kg	LxWxH cm / kg	Protected & compatible power generator (+/-15%)				
					Heating	Heating							
POWERDUCTION 110LG COMPACT <b>NEW</b>	400V, 3~50/60 Hz	16 mini	11 000	20+60	1.51	5	4	M18 → 1 s	2 mm → 2 s 4 mm → 4 s	Ø10 → 7 s	63 x 33 x 54 / 50	NC	15 kW
POWERDUCTION 110LG	400V, 3~50/60 Hz	16 mini	11 000	20+60	71	5	4	M18 → 1 s	2 mm → 2 s 4 mm → 4 s	Ø10 → 7 s	42 x 42 x 76 / 66.5	59 x 80 x 60 / 86	15 kW
POWERDUCTION 110LG 208-240V	208-240V, 3~50/60 Hz	35 mini	11 000	20+60	71	5	4	M18 → 1 s	2 mm → 2 s 4 mm → 4 s	Ø10 → 7 s	42 x 42 x 76 / 78	59 x 80 x 60 / 90	15 kW
POWERDUCTION 160LG	400V, 3~50/60 Hz	32 mini	16 000	20+60	301	4	6	M20 → 1 s	2 mm → 2 s 4 mm → 4 s	Ø10 → 5 s	78 x 58 x 118 / 128	80 x 61 x 120 / 140	22 kW
POWERDUCTION 160LG 208-240V	208-240V, 3~50/60 Hz	45 mini	16 000	20+60	301	4	6	M20 → 1 s	2 mm → 2 s 4 mm → 4 s	Ø10 → 5 s	78 x 58 x 118 / 113.5	80 x 60 x 120 / 126	22 kW
POWERDUCTION 220LG	400V, 3~50/60 Hz	32 mini	22 000	20+60	301	4	6	M45 → 3 s	4 mm → 3 s 8 mm → 9 s	Ø10 → 4 s	70 x 60 x 120 / 98	80 x 60 x 132 / 139	22 kW
POWERDUCTION 220LG 10M	400V, 3~50/60 Hz	32 mini	22 000	20+60	301	4	10	M45 → 3 s	4 mm → 3 s 8 mm → 9 s	Ø10 → 4 s	70 x 60 x 120 / 132.5	80 x 60 x 120 / 144.5	22 kW

# SMALL Ø16

## INDUCTORS

* = original equipment	S90 058927	S70 061569	S180 059269	S20/B1 (20°) 064874	S180/B1 064881	S180/B3W 067899	S180/B6 087002
37 LG	✓*			✓			
39 & 50 LG				✓ with adapter 285			
110, 160 & 220 LG				✓ with adapter 325			

	S20/D20 078796	S90/D20 078871	S180/D20 069985
Ø 20			
Ø 25	S20/D25 078802	S90/D25 078888	S180/D25 069992
Ø 30	S20/D30 078819	S90/D30 078895	S180/D30 070592
Ø 35	S20/D35 078826	S90/D35 078901	S180/D35 070608
Ø 40	S20/D40 078833	S90/D40 078918	S180/D40 070615
Ø 45	S20/D45 078840	S90/D45 078925	S180/D45 070622
Ø 50	S20/D50 078857	S90/D50 078932	S180/D50 070639
Ø 55	S20/D55 078864	S90/D55 078949	S180/D55 070646
37 LG	✓ S20/D20-D35, S90/D20-D35, S180/D20-D35		
39 & 50 LG	✓ with adapter 285		
110, 160 & 220 LG	✓ with adapter 325		

S180 Heat Tube		S20 Pre Heat	
Ø 24	D24 086982	NEW	D24 086975
Ø 30	D30 086999	NEW	
Ø 37	D37 078604		
Ø 40	D40 078611		
Ø 50	D50 078628		
39 & 50 LG	✓ with adapter 285		✓ with adapter 285
110, 160 & 220 LG	✓ with adapter 325		✓ with adapter 325

DIFFICULT ACCESS ADAPTERS			
	90°-S 082663	✓ with adapter 180/B1 ✓ with adapter 180/B3W ✓ with adapter 180/B6	✓ with adapter S180 HEAT TUBE D37 ✓ with adapter S180 HEAT TUBE D40 ✓ with adapter S180 HEAT TUBE D50

ADAPTERS	
	285 M28 Ø16 064485
	325 M32 Ø16 064508
39 & 50 LG	✓ 285 M28 Ø16
110, 160 & 220 LG	✓ 325 M32 Ø16

Boxes - Boîtes		
	285/B type W for 39LG & 50LG 072497	included: S20/B1 (x1) S180/B1 (x1) S180/B3 (x1) 285 (x1) B1 (x1) B3 (x1)
	325/B type W for 110LG, 160LG & 220LG 072503	included: S20/B1 (x1) S180/B1 (x1) S180/B3 (x1) 325 (x1) B1 (x1) B3 (x1)
	L box 065796	included: L70 (x1) L180 (x1)

Trolley for inductor for adapter 32L Chariot pour inducteur pour adaptateur 32L 075955		4 to 8 wheels
--	--	---------------

Ferrites - Ferrites - Ferritaufsatz											
	B1 053823		B1 (x5) 079380		B2 053458		B3 067875		B4 053755		B5 079489
	B1 056909		B2 056916		B3 072527		B4 054844		Spiral 069701		Leveling 087736

Glue kit for inductor Kit de colle pour inducteur 075948		Colle-Stick bi-composants Power Epoxy 150°C 2 x 15 g / 50 ml 054851
--	--	--

# LARGE Ø32

## INDUCTORS

* = original equipment	L90 (90°) 059788	L70 (70°) 059771	L180 059795	L180/Spiral 065000	L180 Leveling 087729	L20/B4 067882	L180/B4 079786	L20 Alu Glove 069114
39 & 50 LG	✓ with adapter 28L							
110, 160 & 220 LG	✓ with adapter 32L*		✓ with adapter 32L		✓ with adapter 32L*	✓ with adapter 32L	✓ with adapter 32L	✓ with adapter 32L

Ø	Pre-heating - Préchauffe Heating - Chauffage	Pre-heating & Fretting - Préchauffage et Frettage		
Ø 60	✓	L20/D60 078956	L90/D60 079106	L180/D60 069923
Ø 70	✓	L20/D70 078963	L90/D70 079113	L180/D70 069930
Ø 80	✓	L20/D80 078970	L90/D80 079120	L180/D80 069121
Ø 90	✓	L20/D90 078987	L90/D90 079137	L180/D90 069947
Ø 100	✓	L20/D100 078994	L90/D100 079144	L180/D100 069954
Ø 110	✓	L20/D110 079007	L90/D110 079151	L180/D110 069961
Ø 120	✓	L20/D120 079014	L90/D120 079168	L180/D120 069978
Ø 130	✓	L20/D130 079021	L90/D130 079175	
Ø 140	✓	L20/D140 079038	L90/D140 079182	
Ø 150	✓	L20/D150 079045	L90/D150 079199	
Ø 160	✓	L20/D160 079052	L90/D160 079205	Production on request
Ø 170	✓	L20/D170 079069	L90/D170 079212	
Ø 180	✓	L20/D180 079076	L90/D180 079229	
Ø 190	✓	L20/D190 079083	L90/D190 079236	
Ø 200	✓	L20/D200 079090	L90/D200 079243	
39 & 50 LG		✓ with adapter 28L		
110, 160 & 220 LG		✓ with adapter 32L		

Pre-heating & Fretting - Préchauffage et Frettage			
> Ø 200 & < Ø 300	Production on request		
110, 160 & 220 LG	✓ with adapter 32L		

Brasing - Brasage			
* = original equipment	L90 BRAZ 16 Ø 1/2" / 16 mm 076907	L90 BRAZ 28 Ø 1" / 28 mm 076921	L180 BRAZ 16 Ø 1/2" / 16 mm 076914
			L180 BRAZ 28 Ø 1" / 28 mm 076938
110, 160 & 220 LG	✓ with adapter 32L*		

Protection kit for BRAZ inductors - Kit de protection pour inducteurs brasage 077515	
--	--

Protection kit for loop inductors - Kit de protection pour inducteurs boucle 077386	
---	--

ADAPTERS	
	28L M28 Ø32 064492
	32L M32 Ø32 064515
39 & 50 LG	✓ 28L M28 Ø32
110, 160 & 220 LG	✓ 32L M32 Ø32

Exchanger - Échangeur	
	L180R X Production on request
110, 160 & 220 LG	✓ with adapter 32L

# COMPLETE Ø28

## INDUCTORS

	C20/B1 056862		C180/B1 056879		C180/B2 056886
37 LG					
39 & 50 LG	✓*				✓
110, 160 & 220 LG					



# TRUCK TOOLS & MOBILE LIFTS

## TRUCK TOOLS

TROLLEY IW1	111
MULTITOOL TRUCK	111

## CAR LIFTS

SPOT LIFT	112
QUICK LIFT / AIR JACKS	114
ERGO LIFT	115
MANUAL DOOR LIFT / WHEEL LIFT	116



INVEST IN THE FUTURE



TROLLEY IW1 / MULTITOOL TRUCK

# TRUCK TOOLS

**TROLLEY IW1**  
Impact wrench trolley -  
Support de clé à choc

max 6.5 bar

**max 20 kg**

063136

### OPTIONS



Huile hydraulique  
- Hydraulic oil  
1l  
053397

Weight, vibrations  
& torque suppression -  
Suppression du poids,  
des vibrations et du couple



Youtube

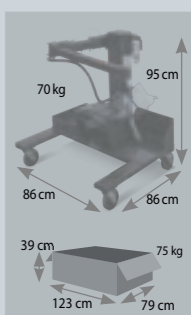
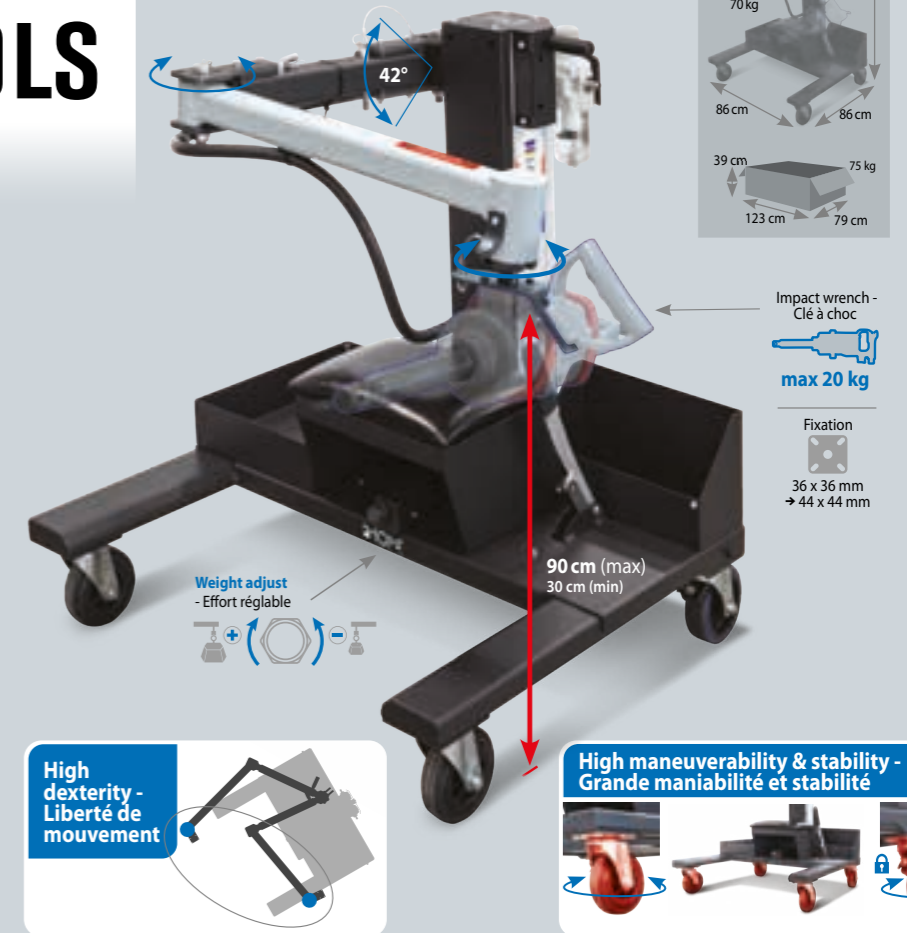

Impact wrench -  
Clé à choc  
**max 20 kg**

Fixation  
36 x 36 mm  
→ 44 x 44 mm

Weight adjust  
- Effort réglable

High maneuverability & stability -  
Grande maniabilité et stabilité

High dexterity -  
Liberté de mouvement

## MULTITOOL TRUCK

**SAFE EN 14238 + A1**

**max 200 kg**

067158

### INCLUDED



Lifting tool for brake caliper  
- Outil de levage pour étrier  
de frein - Hebewerkzeug für  
Bremssattel



Brake caliper



Lifting tool for battery -  
Outil de levage pour batterie  
- Hebewerkzeug für Batterie



Truck batteries



Lifting tool for wheels -  
Outil de levage pour roues  
- Hebewerkzeug für Räder



**SAFE**  
**EN 14238 + A1**

**ULTRA COMPACT**  
**103 cm**

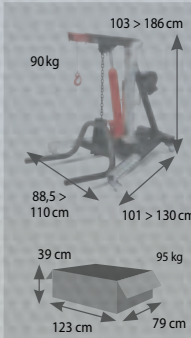

### HEALTH CARE

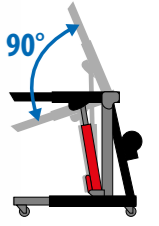
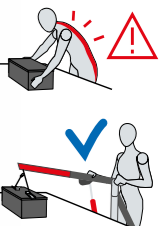

111

TRUCK TOOLS





SPOT LIFT

# MOBILE LIFTS

## SPOT LIFT EASY

max Air 8 bar **SAFE EN 1494**  
**max 2.2 t**

### HEALTH CARE



### High stability - Haute stabilité



Included 220 bar 053588

**SAFE EN 1494**

### SECURITY

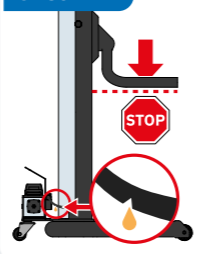

### OPTIONS

Hydraulic oil 1L - Huile hydraulique 1L 053397

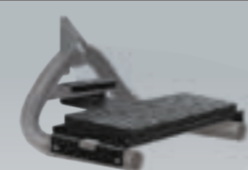

Rocker panel lifting tool - Outil de levage pour bas de caisse - Auflage für Seitenschweller 053236



## SPOT LIFT PRO

max Air 8 bar **SAFE EN 1494**  
**max 2.2 t**

053557

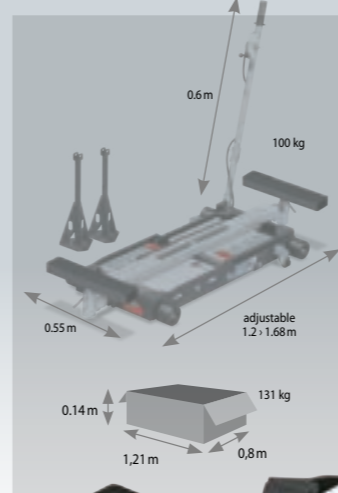

## SPOT LIFT PRO MOB

max Air 8 bar **SAFE EN 1494**  
**max 2.2 t**

055896

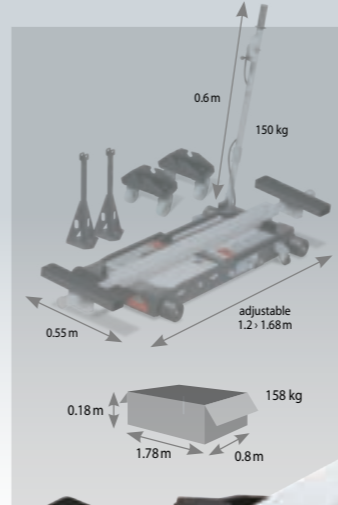

**60 cm (max)**  
**14 cm (min)**



### AUTO ROLL

min 500 mm  
max 1700 mm (AUTOROLL 1.0m)  
max 2240 mm (AUTOROLL 1.55m)  
**2.5 t max**

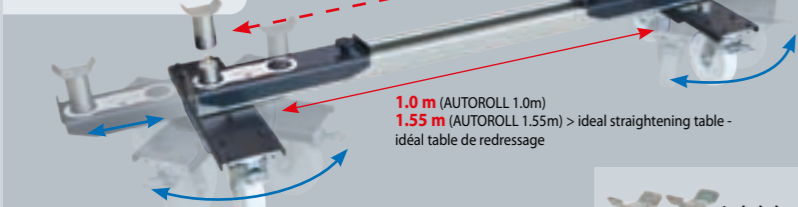

**AUTO ROLL 1.0 m / 1.2 t**  
059047



**AUTO ROLL 1.55 m / 1.2 t**  
063839

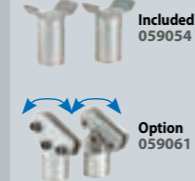
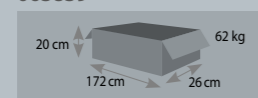

### AFTER LIFT AUTO ROLL

1 2  
**2.5 t max**

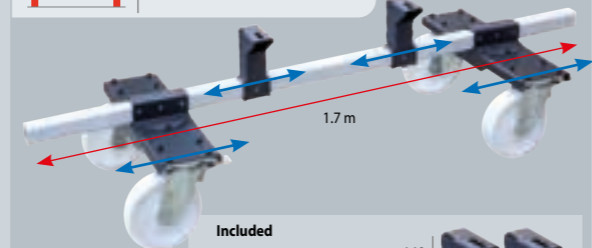

067967



### WHEEL TROLLEYS - Tabourets de manutention - Radhocker

048768

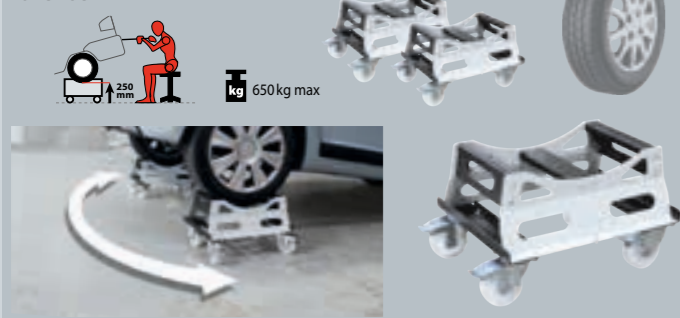

### MECHANICAL LIFTING JACKS - Chariots de manutention prise sous roue - Kfz-Montagelift, fahrbar

071995

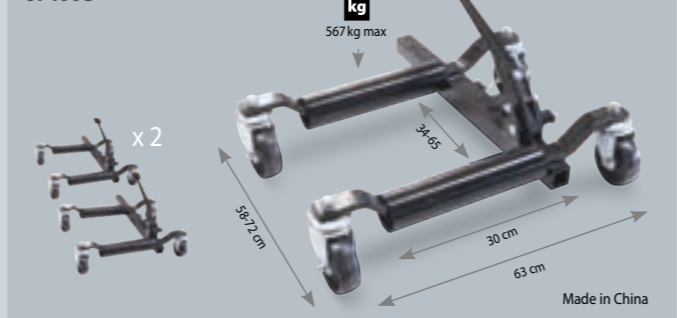

### OPTIONS

Height adjuster for 4x4 & utility vehicles - Réhausseur pour 4x4 et utilitaires - Erhöhung f. 4x4 und Leicht-LKW



**Pads - Patins** for Audi & BMW (x 2) 053717

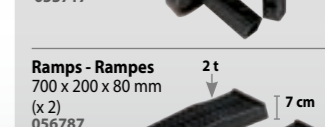

**Ramps - Ramps** 700 x 200 x 80 mm (x 2) 056787



### OPTIONS

**SPOT LIFT PRO MOB** Réhausseur pour 4x4 et utilitaires - Height adjuster for 4x4 & utility vehicles - Erhöhung f. 4x4 und Leicht-LKW



**Patins - Pads** for Audi & BMW (x 2) 061606

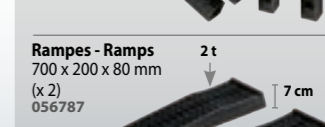

**Ramps - Ramps** 700 x 200 x 80 mm (x 2) 056787



113

SPOT LIFT

MOBILE LIFTS

**QUICK LIFT L520E**

062184

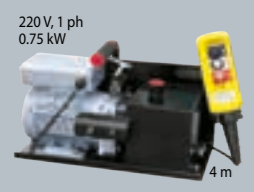

220 V, 1 ph  
0.75 kW

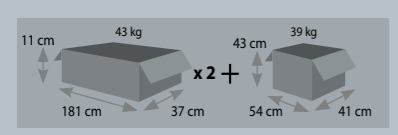

Made in China

**OPTIONS**

- Extensions 1680 mm x 2 (066328)
- x4 Patins à rainures (071933)
- Pads for SUV x4 - Patins pour SUV x 4 (065017)
- Wall mount - Support mural (071926)

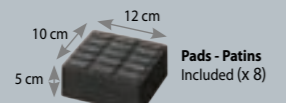

**SAFE EN 1493** 2.5 t max

**ERGO LIFT 1000 ROLL**

Air 7-8 bars **SAFE EN 1493**  
max 2.5 t



High stability - Haute stabilité

QR code, Youtube logo

**PATENT PENDING**  
n° EP4474334

Handle for adjusting the automatic locking support arms  
- Poignée de positionnement des bras porteurs avec verrouillage automatique

**SAFE EN 1493**

included: (x4) 4 cm + (x4) 6 cm

95 cm (max)

30 cm, 23 kg, 49 cm, 37 cm, Wheel kit (076778) x 4

Pump included (082977): 29 cm, 8.7 kg, 38 cm, 18 cm

Easy connection

Hydraulic Safety

Security 100%

**AIR JACKS**

**DOUBLE BAG AIR JACK 082878**

60 x 52 x 14.5 cm  
14.8 kg

**SAFE EN 1494**

12 kg  
LIGHT & COMPACT

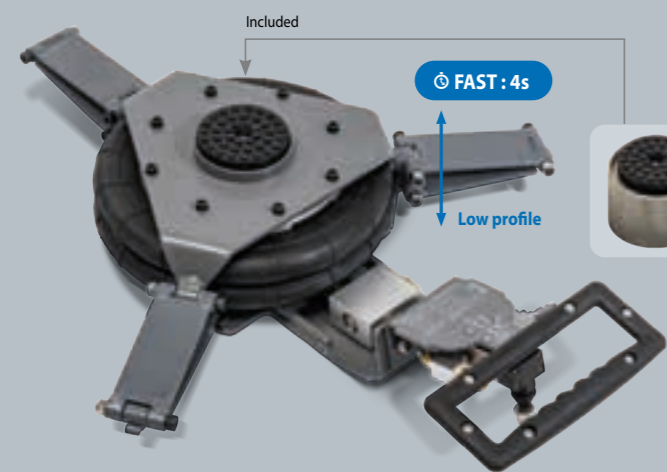

**TRIPLE BAG AIR JACK 082885**

62 x 56.5 x 18 cm  
17.8 kg

**SAFE EN 1494**

14 kg  
LIGHT & COMPACT

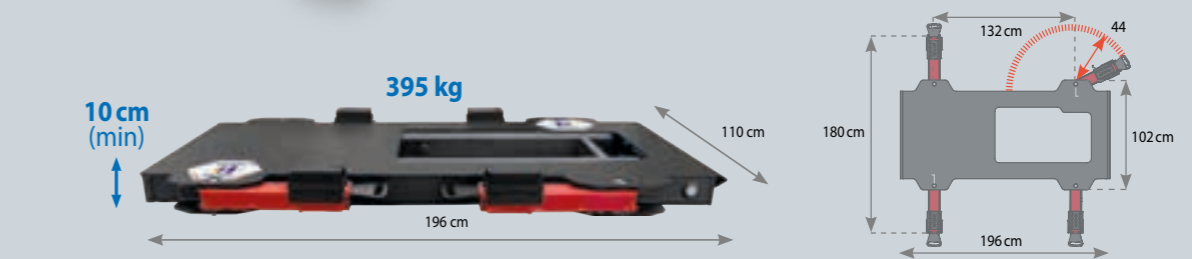
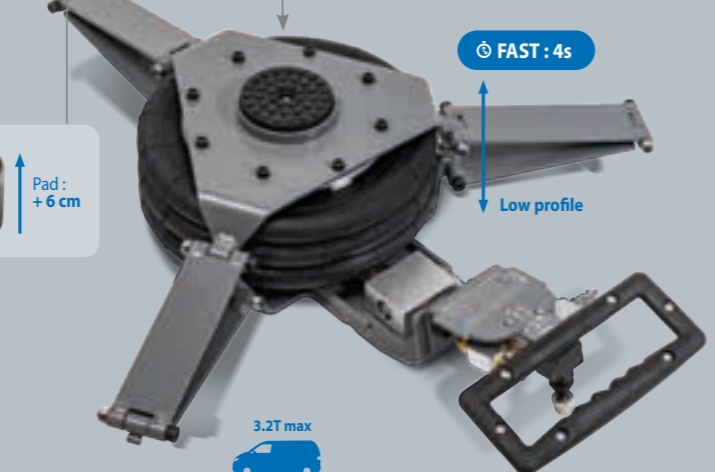

**OPTIONS**

- Pads for SUV x4 - Patins pour SUV x 4 (065017)
- Ergo Lift ramps x2 - Rampes Ergo Lift x2 (082717)
- Capacity: max 3.5 t
- Pack ERGO LIFT 1000 ROLL + wheels (076792)
- Pack ERGO LIFT 1000 ROLL + wheels + ramps (082984)

## ERGO DOOR LIFT

Ergonomic door handling trolley  
 - Support Pro ergonomique de manutention de portière  
 - Ergonomische Türhandhabungsunterstützung  
 082670

Manufactured by GYS = SUPER PRO

117 x 28 x 27 cm  
 40 kg

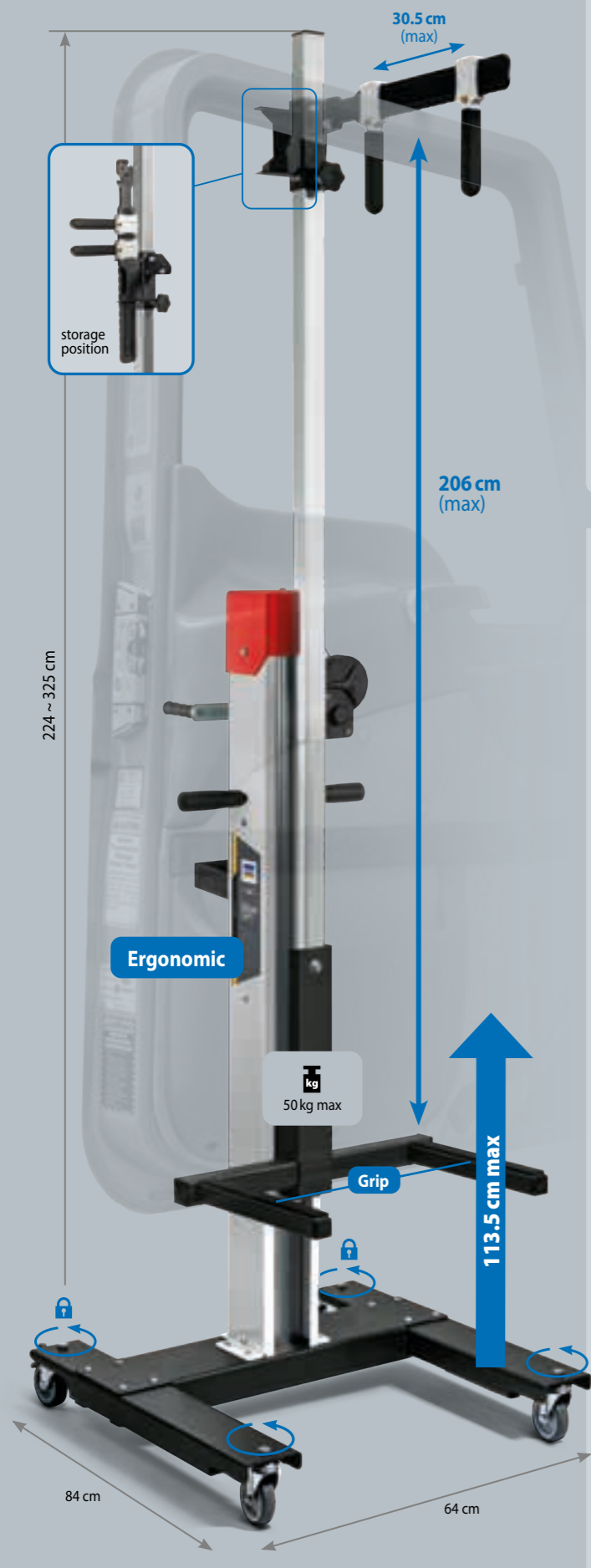

## Option

Wide door accessory  
 - Accessoire pour portière large  
 - breites Türzubehör  
 082700



## MANUAL WHEEL LIFT

Wheel lift trolley  
 - Lève roue à treuil  
 - Radmontage-Heber  
 061385

Manufactured by GYS = SUPER PRO

min: R13 / 135 / 65  
 max: R22 / 300 / 35  
 40 kg max

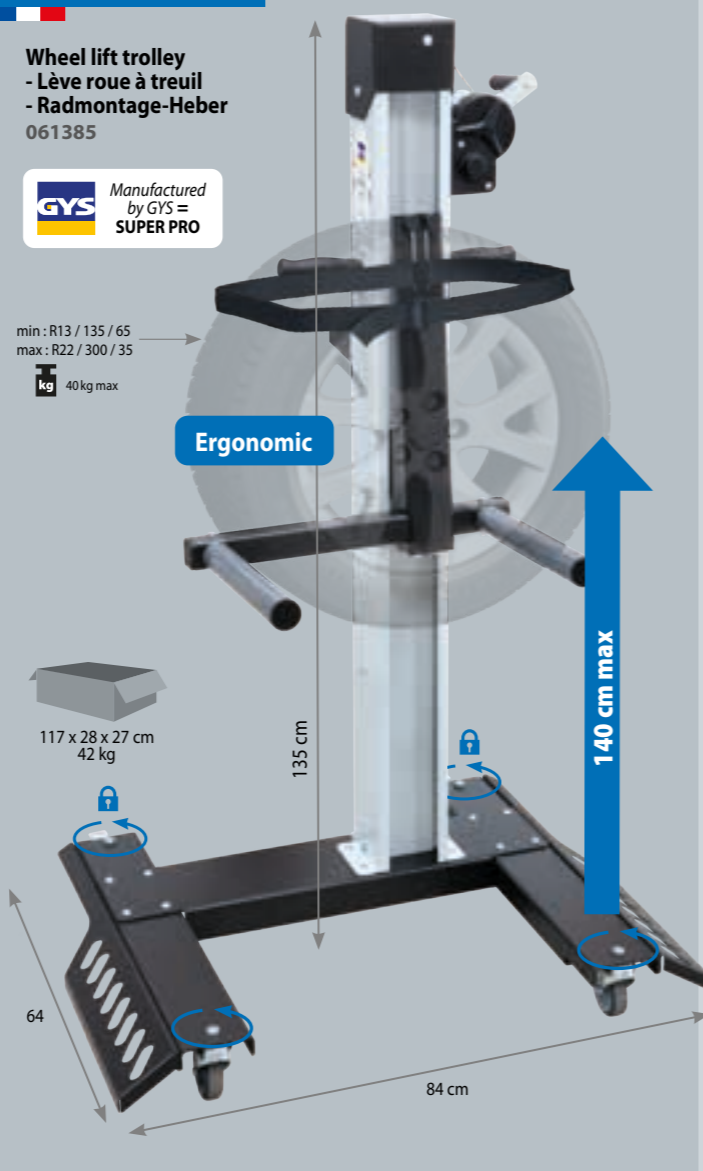

# + ACCESSORIES

WELDING HELMETS	118
FUME EXTRACTION	121
WINDSCREEN REPAIR	122
BUMPER REPAIR	124
HAND TOOLS	126
PNEUMATIC TOOLS	130
WORKING LIGHTS	132
SANDING & DUST EXTRACTION	134
WORKING SUPPORTS	136
SAFETY PROTECTION	141
ELECTRIC VEHICLES	142



# HELMETS VENTILATED

IDEAL

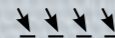

DIGITAL MEMORY & REGULATIONS ELECTRONIC



**GYSMATIC 3/9-13 G AIR**  
065727  
069602

100 x 60 mm

0.04 ms



**GYSMATIC 5-13 G AIR XXL**  
047846  
028852

100 x 83 mm

0.1 ms



included with GYSMATIC 5/13 G AIR XXL

**Filtration class EN 12941: TH2 P R SL**  
Air 165 / 200  
220 L/min  
Battery included

**OPTION Filter TH3**  
065734



Battery charger  
037472  
028869



Battery included  
037465



038424 x1



038417 x5

LENSES - Verres - Schutzgläser

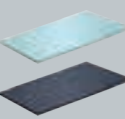

			TRUE COLOR	HF	DELAY								L x W x H cm / g	MASK BRAND	
114 x 133 (x10)	043893	G: 106 x 66 (x10)	043886	<b>GYSMATIC 3/9-13 G AIR</b>	3-9>13	0.04 ms	✓	0.10>0.90 s	1/1/1/2	4 HIGH SENSITIVITY	XL: 100x60 mm	✓	Simple	59 x 35 x 29 / 1230	Gys
114 x 133 (x10)	043893	106 x 89,5 (x10)	046825	<b>GYSMATIC 5-13 G AIR XXL</b>	4-5>9 / 9>13	0.04ms	✓	0.1 > 0.9 s	1/1/1/1	4 HIGH SENSITIVITY	XXL: 100x83 mm	✓	Multi Pro	59 x 35 x 29 / 5000	Gys

## FUME EXTRACTION SYSTEMS - Aspirateurs de fumée - Rauchgasabsauggerät

**UNI 2.0 RE**

- 400V 3~
- 50 Hz
- 1100 W
- 1500 m<sup>3</sup>/h max
- arm 3 m
- no plug
- 100 kg
- extraction 0.5 m/s

122 x 67 x 145 cm / 111.5 kg

061545



Ø 150 mm

Included  
**Pré filtre, treillis Aluminium**  
Class of filtration G3 EN 779  
+ **Filtre - Coal Filter EPA E12**  
EN 779, Filtration >99.5 %  
046467

Options  
**Filtre à charbon actif - Coal filter**  
✓ UNI 2.0 RE  
064522

**EVO 2.1 RE**

- 230V 1~
- 50 Hz
- 1100 W
- 1200 m<sup>3</sup>/h max
- occasional
- arm 3 m
- included
- 85 kg

96 x 95 x 162 cm / 114 kg

061552



Ø 150 mm

792 mm

347 mm

Patented - Breveté

Included  
**Pré filtre, treillis Aluminium**  
Class of filtration F15 G2 EN 779  
+ **Filtre - Coal Filter HEPA H13**  
EN 779, Filtration >99.95%  
046498

## FUME EXTRACTION TORCHES - Torches aspirantes - Rauchgas-Absaugbrenner - Antorcha con aspiración de humos



BINZEL

	Steel/Stainless steel - Acier/Inox - Stahl/Edelstahl			
	AIR		LIQUID	
	150 A	250 A	350 A	500 A
original equipment	M6	M6	M8	M8
Ø	Ø 0.8	Ø 1.0	Ø 1.2	Ø 1.2
X % 40°C - ArCO <sub>2</sub>	150A - 60%	200A - 60%	290A - 60%	380A-100%
GRIP	GRIP	GRIP	GRIP	GRIP
L	3m	3m	4m	4m
Ref.	043251	040540	040557	040564

For fume Extraction Torches - Pour torches aspirantes

BINZEL  
073715



- 230V / 1 ~, 1100 W
- 230 m<sup>3</sup>/h max
- 190 mbar max
- 25 kg, 590 x 425 x 825 mm
- 76 db
- Filter auto cleaning system - Système de nettoyage automatique du filtre - Automatische Filterabreinigung

Filtre Classe M, EN 60335-2-69

included: 5 m, Ø50



• External evacuation Ø50 (hose not included)  
• Évacuation extérieure Ø50 (tuyau non inclus)

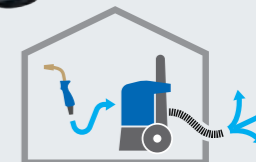

**PROFESSIONAL BOX SET FOR WINDSCREEN REMOVAL** - Coffret de découpe pare-brise  
- Frontscheiben-Trennsystem für Akkuschrauberbetrieb

MADE IN  
HIGH  
QUALITY  
GERMANY

057654

included  
Axe enrouleur  
068100

included  
65 m  
resistance 170 kg  
Ø 0.79 mm  
058125

optional  
65 m  
resistance 190 kg  
Ø 0.92 mm  
069275



**OSCILLATING PNEUMATIC SAW FOR WINDSCREEN REMOVAL** - Couteau pneumatique de découpe pare-brise  
- Druckluft-Trennmesser für Windschutzscheiben

057623



Included  
57 mm  
057845

90 mm  
057852

8 mm  
057876

35 mm  
057838

U  
36 mm  
057869

**REMOVAL TOOL FOR WINDSCREEN WIPER ARMS** - Extracteur d'essuie-glace - Wischerarm-Abzieher

UNIVERSEL  
057630



EXPERT

Accès difficile  
- Difficult access  
057647



**WINDSHIELD CUTTING KIT** - Système de découpe pare-brise à cliquet  
- Set zum Lösen von Windschutzscheiben

054738

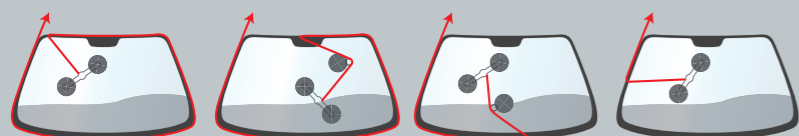

**DASHBOARD PROTECTOR** - Protections tableau de bord  
- Armaturenbrett Schutz

053120



**WINDSHIELD CUTTING TOOL** - Outil découpe pare-brise  
- Windschutzscheiben Demontage-Set

051935



**WINDSCREEN JOINT-CUTTING KIT** - Kit découpe joint de pare-brise - Scheibentrenn-Werkzeug-Set

051898



Corde à piano torsadé (22 m)  
- Windscreen seal cutting wire  
(twisted)  
- Piano-Schneiddraht, gedreht,  
22 m Rolle  
051911

Corde à piano carré (50m)  
- Windscreen seal cutting wire  
(square)  
- Vierkant-Draht,  
50 m Rolle  
051881

**SUCTION LIFTING PADS** - Ventouses - Saugnapfwerkzeug für Spiegelgläser

056695



051966



x6  
057609



**COMPRESSED AIR POLISHER** - Renov'Polycarbonate - Druckluftpolierer

Complete pack

1 orbital sander  
+ 1 polisher  
- 1 ponceuse orbitale  
+ 1 lustreuse

052086



2 SPEED

+

+

+

052055

052062

052079

+

+

sander Ø75  
057494

polisher Ø75  
058224

Ø 76

P 500 (x 10)  
P 800 (x 10)  
P 1500 (x 10)  
P 3000 (x 10)

P 500 x 50 052017  
P 800 x 50 052024  
P 1500 x 50 052031  
P 3000 x 50 052048



**HOT STAPLER FOR BUMPER REPAIR** - Agrafeuse pour réparation pare-chocs - Stoßstangen Reparatur Kit



052925

INCLUDED:  
x20 x20 x20 x20 x20

MADE IN TAIWAN



**PORTABLE**  
Battery operated - Sur batterie  
058118

included  
Li-ion battery 3.7 V  
048669  
included adapters:  
EUR, UK, USA & AUS

Charger included  
048652

MADE IN TAIWAN

INCLUDED:  
Ø 0.6, x100 Ø 0.8, x100  
Ø 0.6, x100

Adjustable

Staples - Agrafes	V	U	N	W	M
	Inside corner - Angle interne étroit Ø 0.7 mm	Crack alignment - Alignement de fissure Ø 0.7 mm	Large crack - Fissure importante Ø 0.7 mm	Internal angle - Angle interne Ø 0.7 mm	External angle - Angle externe Ø 0.7 mm
	x 100 047990	x 100 047983	x 100 047976	x 100 047969	x 100 047952
	052413				
	= x 50	+ x 50	+ x 50	+ x 50	+ x 50

**PLASTIC WELDING STATION** - Station de soudage des plastiques - Kunststoff-Schweißset



320 W - 230 V, 1~50 Hz  
Temperature: 160 < 480°C  
▲ 3.4 kg  
Length of hose: 1 m  
Air flow: 24 l/min

Station seule  
- Station only  
064072

Ø 5 mm  
066694

Ø 8 mm  
066700

Station	PP / EPDM			Pressure wheels	Mini milling machine	Scrapper
	4mm (x10)	6mm (x10)	8mm (x10)			
064072	✓					
070974			✓			



**PIERCING KIT FOR BUMPER SENSORS** - Coffret de perçage pare-chocs pour détecteurs - Lochwerkzeug für Stoßfänger



NEW

included Ø 10 mm

Freezer spray  
- Spray refroidisseur  
-50 °C  
400 ml  
(x 12)  
048898

Box 10 diameters  
059139

Box 16 diameters  
085824

Ø 17-18-18,2  
19-20-22,5-24  
26-26,7-32 mm

Ø 18.0 - 18.2 - 18.4 - 18.6  
24.0 - 26.0 - 26.5 - 26.7  
27.4 - 28.1 - 29.3 - 32.0  
32.5 - 34.4 - 37.4 - 38.9 mm

**FREEZER**

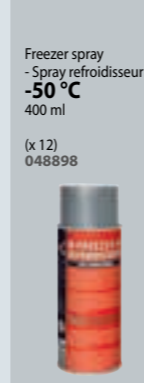

**WELDING KIT FOR PLASTICS** - Kit de soudage des plastiques - Kunststoff-Schweißset

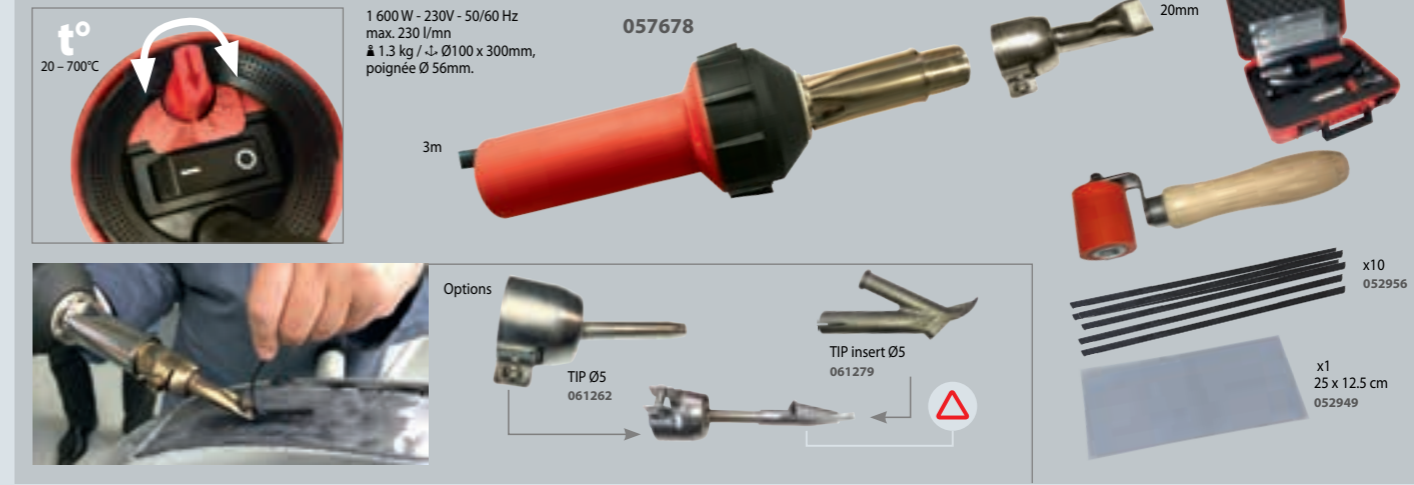

1 600 W - 230V - 50/60 Hz  
max. 230 l/min  
▲ 1.3 kg / -L- Ø100 x 300mm,  
poignée Ø 56mm.

057678

3m

20mm

Options

TIP Ø5  
061262

TIP insert Ø5  
061279

x10  
052956

x1  
25 x 12.5 cm  
052949

**TOOL FOR REMOVING BUMPER** - Outil de déclipsage pare-chocs



076518

x15  
076525

**HAND SEAMER FOR PLASTIC REPAIR** - Pince de serrage pour réparation des plastiques



082014

**MULTI-CLIP PLIER** - Pince multi-clip



083813

DURABLE  
HIGH-CARBON  
STEEL

Cut + Grip

**BRAZING AUTOMOTIVE PLASTICS REPAIR KIT** - Coffret de réparation des plastiques automobiles - Kunststoff Reparatur Set

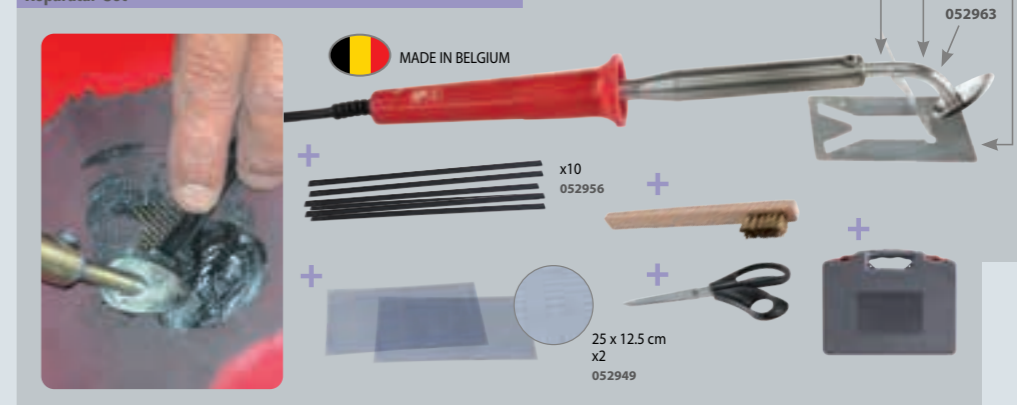

052932

MADE IN BELGIUM

x10  
052956

25 x 12.5 cm  
x2  
052949

057258

052963

**WORKSTATION PREMIUM 5 DRAWERS - Servante premium 5 tiroirs**

± 64 kg  
Capacity 320 kg



4 Keys - 4 Clés

**Complete carbody workstation**  
080119

Workstation only  
076143

included



**HAND CHISEL FOR CAR BODY**

- Burins  
- Meißel für Karosserie

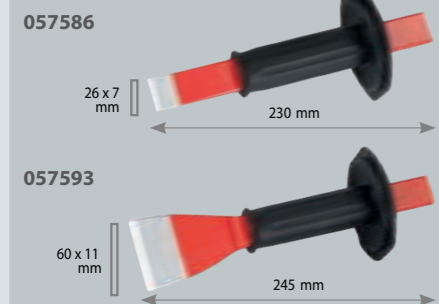

**SET OF 4 NYLON CHISELS - Jeu de 4 burins en nylon - 4 Kunststoffmeißel**

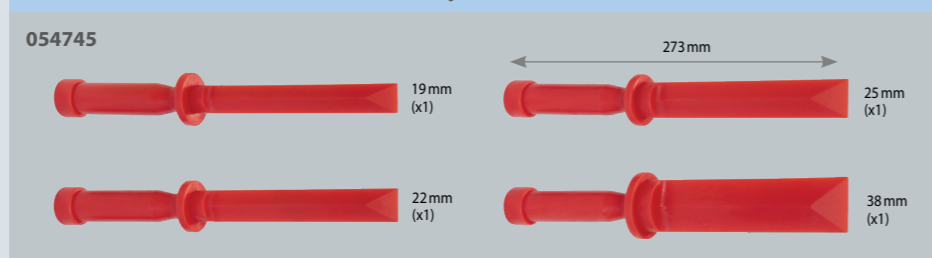

**SET OF 3 CHISELS - Lot de 3 burins de séparation éléments collés - 3 Meißel**

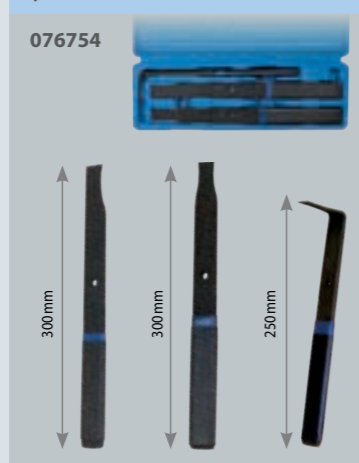

**SET OF 30 TOOLS FOR SCRAPING/SANDING AND PAINT REMOVAL - Outils de dégarnissage et raclage - Polster & Schaber Kit**



**SET OF 3 SCRAPING KNIVES - Couteaux racloirs**



**HAND TOOLS - Ausbeulwerkzeug**

• FULL PACK =  
061637



MADE IN HIGH QUALITY GERMANY

+ MEDIUM PACK  
051133

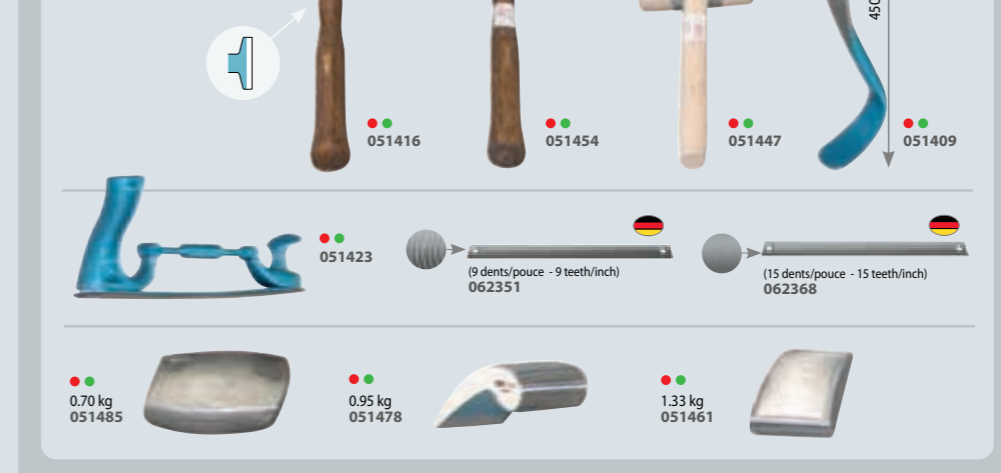

**PLANISHING HAMMER BLACKTEC®**

077270  
Rubberised gripping - Manche en caoutchouc



**ALU HAMMERS - Marteaux alu**

020986

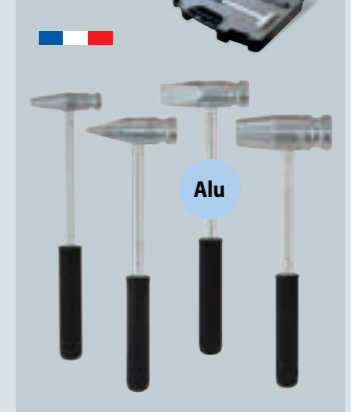

**PLANISHING KIT FOR CAR BODY (SET OF 3 HAMMERS + 4 DOLLYS) - Kit marteaux et tas - Karosseriehammer & Handfaust Kit**



**SET OF 3 ALU HAMMERS + 4 ALU DOLLIES - Kit marteaux alu et tas alu - Karosseriehammer & Handfaust Kit**





**CONTOUR GAUGES** - Jauges de profil - Konturenlehre

052840

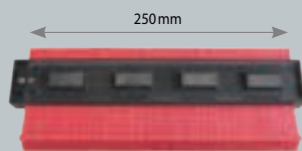

057265

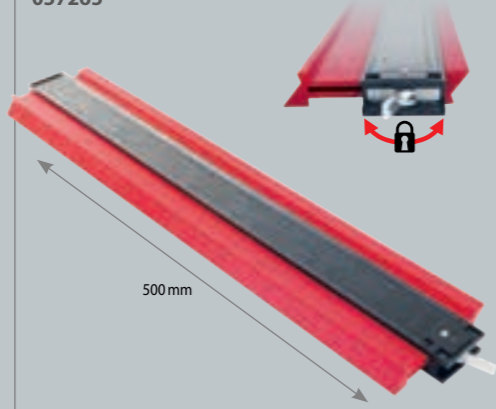
**LIP PLIER** - Pince à lèvres - Falz zange gebogen

079649

**SET OF PLIER + 10 STAPLES**

- Coffret pinces à agrafes

082175

0 - 2.5 mm (x10)  
0821822.5 - 5 mm (x 10)  
082199**POSITIONING CLAMP** - Pincettes de maintien bord à bord - I-Stoß-Lehre

043190

(x4)

**DOOR HINGE STRAIGHTENER** - Redresseur de charnière de porte - Türgelekausrichter

051102

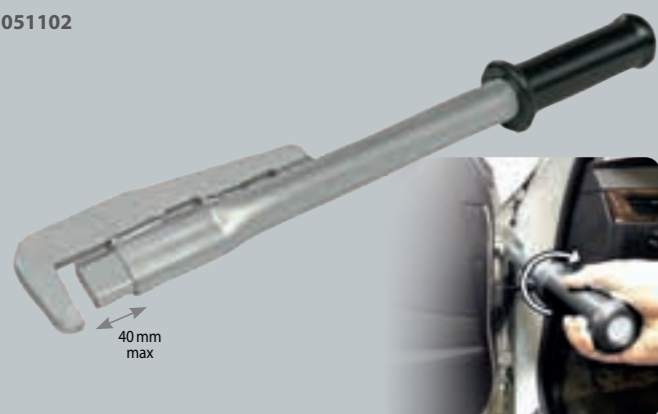

40 mm max

**DOOR ALIGNING TOOL** - Outil d'alignement de portière - Türausrichtungswerkzeug

083424

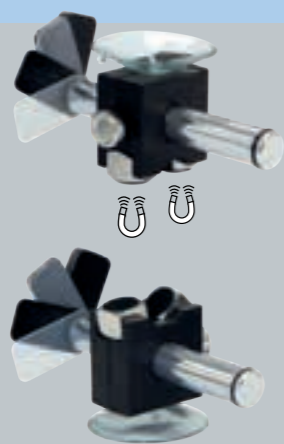
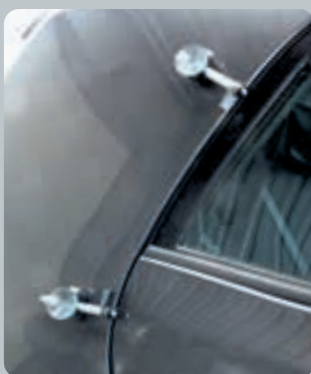

Greater access to restricted areas

**GAPPING GAUGES** - Jauges de positionnement - Spaltmaßlehrex2  
054752**FENDER ROLLER TOOL SET** - Outil de remise en forme passage de roue - Kotflügelrollen-Werkzeugsatz

060791

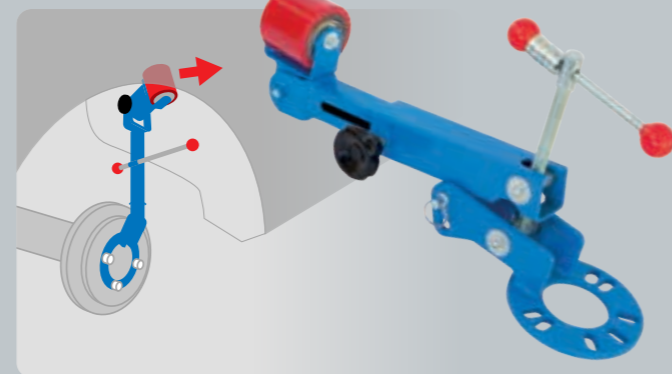
**MULTI-CLIP PLIER** - Pince multi-clip

083813

DURABLE HIGH-CARBON STEEL



Cut + Grip

**BURR REMOVER** - Outil d'ébavurage - Gratentferner

079854

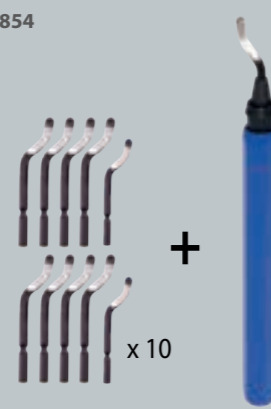

x 10

**BODY LINE TOOL** - Traceur de ligne carrosserie - Markierhilfe für Kanten

078758

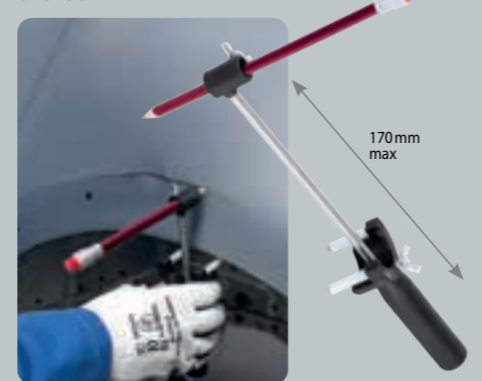

170 mm max

**AXIAL-GRIP PLIERS** - Pincettes axiales

050242

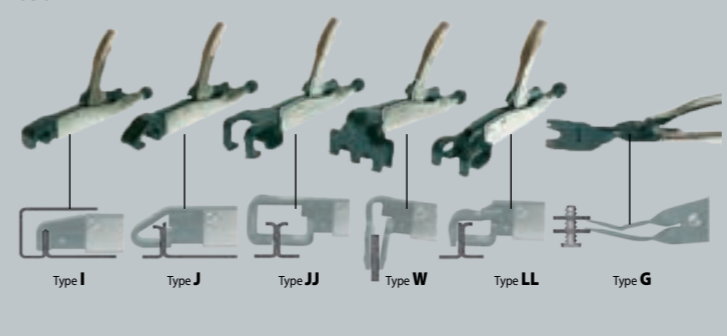

Type I

Type J

Type JJ

Type W

Type LL

Type G

**LOCK-GRIP PLIERS** - Pincettes mono serrage

280 mm

061378



x 6

80 mm

610 mm

061354



x 2

410 mm

460 mm

061361



x 4

240 mm

Flat noze - 610 mm

061347



x 2

410 mm

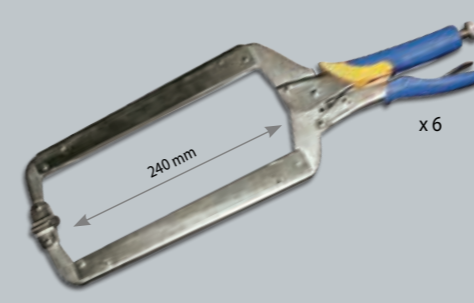
Flat noze - 460 mm  
050112

x 6

240 mm

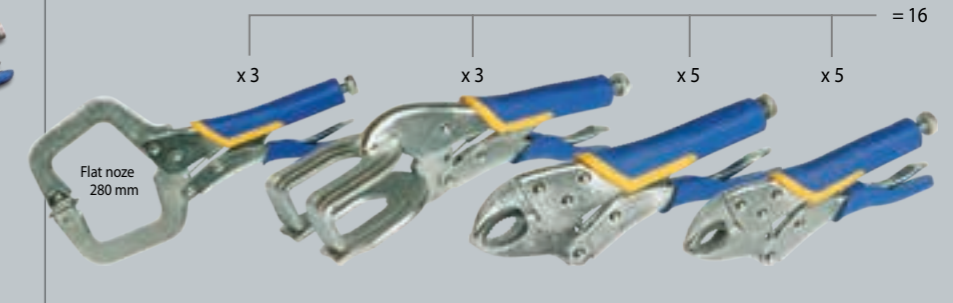
KIT:  
050266

x 3

x 3

x 5

x 5

= 16

Flat noze  
280 mm

### MINI DISC SANDER - Mini-meuleuse - Druckluftschleifer

051829

Speed adjustment

Ø 75 mm

Speed rpm	Power W	dB	Air consumption l/min	Air pressure bar	cm	kg
18000	200	83	171	6.2	12	0.7

Included (x1) 052468

058248

MINI-FLEXIDISC LAMELLES ZIRCON Ø 50 mm

K 40 (x10) 058255  
K 60 (x10) 058262  
K 80 (x10) 058279

x2 Ø  
Ø 50 & 75 mm

Speed rpm	Power W	dB	Air consumption l/min	Air pressure bar	cm	kg
15000	84	91	6.2	10	0.6	

060906

360°

520 mm

20 mm

Grain 60 (x 5) 060913  
Grain 80 (x 5) 060920  
Grain 100 (x 5) 060937  
Grain 36 céramique (x 5) 062535

Speed rpm	Air consumption l/min	Air pressure bar	cm	kg
16 000	171	6.3	34	1.2

052819

360°

330 mm

10 mm

Grain 80 (x 10) 052833  
Grain 36 céramique (x 20) 062528

Speed rpm	Air consumption l/min	Air pressure bar	cm	kg
16000	171	6.3	26	0.9

051836

90°

Speed rpm	Power W	dB	Air consumption l/min	Air pressure bar	cm	kg
18000	500	81	85	6.2	18	0.7

051799

Ø 13

Speed rpm	Power W	dB	Air consumption l/min	Air pressure bar	cm	kg
800	300	92	170	6.2	18	0.9

057753

Ø 100 mm

± 1.6 mm, x5 057883  
± 0.8 mm, x5 058217

Speed rpm	Power W	dB	Air consumption l/min	Air pressure bar	cm	kg
14000	84	113	6.2	37	1.7	

051867

Ø 50 mm

90°

(x1) 052772

Speed rpm	Power W	dB	Air consumption l/min	Air pressure bar	cm	kg
15000	200	86	85	6.2	18	0.75

051805

(x5) 052789

included 058750

Speed rpm	Power W	dB	Air consumption l/min	Air pressure bar	cm	kg
5000	—	85	255	6.2	10	0.8

051775

Roue gomme 115 x 14 mm 051874  
Roue à découper 115 x 14 mm 051843  
Adaptateur pour brosse 051768

Brose souple Brins droits 0.5 mm 103 x 23 mm 052598  
Brose dure Brins incurvés 0.7 mm 103 x 23 mm 051812  
Brose souple Brins incurvés 0.5 mm 103 x 23 mm 051850

Speed rpm	Power W	dB	Air consumption l/min	Air pressure bar	cm	kg
4000	500	86	102	6.2	280	1.2

079892

Ø 8 mm

0.8 > 1,2 mm

052543

Ø 5 mm

0.8 > 1,2 mm

2 in 1

0.8 > 1,2 mm

063228

Option Tungsten drill Ø 6 mm 054172

054165

Ø 6 mm

STEEL Included 054172

056930

MADE IN HIGH QUALITY POLAND

1) MINI  
2) initial W  
3) final M x < 2.4mm  
4) final D x > 2.4mm

total thickness x=2a+b

Air pressure bar	cm	kg
5	28	2.1

Punching tool for oval holes - Outil de poinçonnage oblongs - Langlochkarosserieblechzange

2.2kg

6 mm 20 mm 052437  
8 mm 20 mm 067264

050464

360°

3 mm

Included: Tungsten Carbide Ø 8 for BORON/UHSS (x1)

HIGH QUALITY

Speed rpm	Power W	dB	Air consumption l/min	Air pressure bar	cm	kg
800	400	85	140	6.5	35	2.3

061460

140 mm

3-edge Ø 8 mm 053069

3-edge	Ø 8 mm	Ø 9 mm	Ø 10 mm
053069	069763	053076	
059849	069770		



### HAND LAMPS - Lampes baladeuses - Handleuchte

#### PORTABLE HAND LAMP 400 L

**400 lumens**

COB LED  
Li-ion  
Charging time: 8h  
**operating time:**  
High position: 2.5 h  
Low position: 5 h  
Top light (1 W): 6 h

↓ 7 x 4 x 23 cm / 0.3 kg  
⊗ 14 x 7 x 24 cm / 0.5 kg

059153



#### PRO PORTABLE LAMP 600 L

**250-600 lumens**

COB LED, 80 CRI  
3.7 V - 2200 mAh Li-ion  
micro USB charging (3.5 h)  
**operating time:**  
High position: 1.5 h  
Mid position: 4.5 h  
Top light (100 lumens): 10 h

IP 54  
↓ 3 x 6 x 19 cm / 0.3 kg  
⊗ 9 x 13 x 24 cm / 0.6 kg

060883



#### 360° PORTABLE WORKSPACE LAMP 1000 L

**60-1000 lumens**

>80 CRI SMD LED  
6500 K  
3.7 V - 5200 mAh Li-ion  
USB charging (4.5h)  
USB power supply  
**operating time** 2 > 27 h

IP 54  
↓ 26 x 7 x 7 cm / 0.5 kg  
⊗ 8 x 8 x 35 cm / 0.7 kg

059764

USB charging /Power supply

Ambiant light



### UNDER BONNET LAMPS - Lampes sous capot - Leuchte für Motorhaube

#### UNDER BONNET HAND LAMP 600 L

**500-1000 lumens**

120 COB LED  
3.7 V - 4000 mAh Li-ion  
charging time: 10/12 h

**operating time**  
High position: 4 h  
Low position: 8 h

↓ 22 x 11 x 68 cm / 1.8 kg  
⊗ 24 x 12 x 70 cm / 2.3 kg

059962



130 > 180 cm

#### UNDER BONNET LAMP AND TRIPOD 800 L

**250-800 lumens**

120 COB LED  
3.7 V - 4000 mAh Li-ion  
charging time: 10/12 h

**operating time**  
High position: 3 h  
Low position: 6 h

↓ 60 x 10 x 7 cm / 1.2 kg  
⊗ 61 x 15 x 12 cm / 2 kg

058002



130 cm

### INSPECTION LAMPS - Lampes d'inspection - Inspektionslampen

#### INSPECTION HEADTORCH 280 L

**100-280 lumens**

3 W COB LED, 80 CRI+, 6500 K  
3.7 V - 1500 mAh Li-po  
micro USB charging  
mains charger not incl.  
**operating time**  
High position: 2 h  
Low position: 6 h  
IP 65  
↓ 8 x 5 x 4 cm / 0.1 kg  
⊗ 5 x 11 x 18 cm / 0.2 kg

060845

60°  
motion detection mode



#### MINI INSPECTION LAMP 350 L

**0-350 lumens**

COB LED  
3.7 V - 1100 mAh Li-ion  
USB charging (3 h)

**operating time**  
3 > 6.5 h

IP 20  
075894

50 lumens  
120 lumens  
350 lumens

279 mm  
146 mm

Aluminium Body

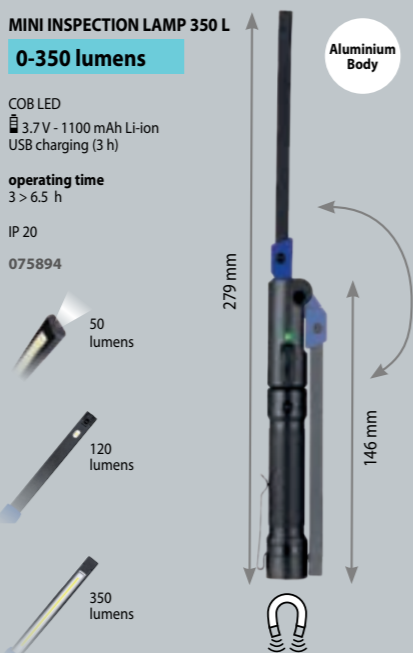

#### PRO INSPECTION LAMP 800 L

**120-800 lumens**

COB LED  
3.7 V - 2600 mAh Li-ion  
USB charging (4 h)

**operating time**  
2.5 > 9 h

IP 54  
075900

120 lumens  
120 / 400 lumens  
150 / 800 lumens

304 mm  
162 mm

Aluminium Body

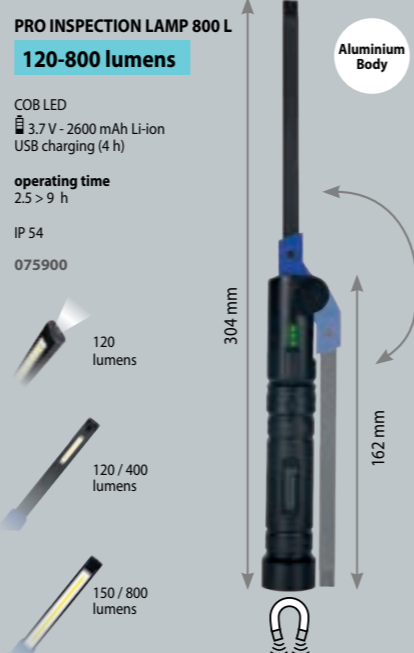

### DETAILING & COLOUR MATCH - Contrôle des couleurs - Fabnpassung & Aufbereitung



100% 98 97 94 99 95 95 98 99 99 92 98 80 98 96 98

R1 R2 R3 R4 R5 R6 R7 R8 R9 R10 R11 R12 R13 R14 R15

CRI CRI+

### LED WORKLIGHTS WITH TRIPOD - Projecteurs led sur trépied - LED-Arbeitsleuchte mit Standfuß

#### TRIPOD LAMP 1800 L

**1800 lumens**

3x 55 COB LED  
total 165 LED  
1.8 m power cord  
059146  
⊗ 95 x 15 x 14 cm / 3.2 kg

adjustable 1.3 m max



#### TRIPOD LAMP 3000 L

**3000 lumens**

35 W COB LED  
2 m power cord  
IP 44  
059979  
↓ 100 x 20 x 9 cm / 3.6 kg  
⊗ 103 x 22 x 10 cm / 4.1 kg

adjustable 1.5 m max



#### TRIPOD LAMP 4000 L

**4000 lumens**

3x 20 COB LED,  
total 60 LED  
3 m power cord  
059986  
↓ 21 x 15 x 114 cm / 5.7 kg  
⊗ 22 x 116 x 117 cm / 6.4 kg

2.3 m max



#### 4500 K

**400 lumens**

SUNCOLOR 1  
COB LED, CRI > 95, 1100 lux  
3.7 V - 2600 mAh Li-ion  
micro USB charging  
**operating time:** 3 h  
↓ 6 x 3 x 19 cm / 0.6 kg  
⊗ 22 x 14 x 10 cm / 0.7 kg  
IP 65  
058477



#### 3 COLORS

**2700 - 4500 - 6500 K**

**350-420-450 lumens**

SUNCOLOR 3  
COB LED, 96 CRI+  
3.7 V - 2600 mAh Li-ion  
micro USB charging (4 h)  
**operating time:** 2.5/4 h  
IP 65  
↓ 4 x 6 x 9 cm / 0.3 kg  
⊗ 9 x 13 x 24 cm / 0.6 kg  
060838



#### 5 COLORS

**2700 - 3500 - 4500 - 5500 - 6500 K**

**500-1000-2000 lumens**

SUNCOLOR 5  
COB LED, 96 CRI+  
11.1 V - 4400 mAh Li-ion  
charger 110/240 V, 5 m cable, 15 V, 1.5 A  
charging time: 3.5 h  
**operating time**  
High position: 2 h, Mid: 4 h, Low: 8 h  
IP 65  
↓ 7 x 23 x 20 cm / 1.2 kg  
⊗ 9 x 25 x 24 cm / 1.9 kg  
060876



#### 5 COLORS

**2500-3500-4500-5500-6500 K**

**50-200-500 lumens**

SUNMATCH 4  
COB LED, 96 CRI+, 700-1400 lux  
3.7 V - 2600 mAh Li-ion, USB charging  
**operating time:**  
High position: 2 h, Low position: 4 h  
IP 65  
↓ 4 x 6 x 19 cm / 0.3 kg  
⊗ 8 x 9 x 21 cm / 0.5 kg  
061651

SCANGRIP®  
COLOUR MATCH



#### UV CURING - SÉCHAGE UV

**UV LED λ 395-400 nm**

**Irradiance 6-15 mW/cm²**

NOVA-UV S  
3.7 V - 5400 mAh Li-ion  
USB charger, 1 m cable, 5 V, 2 A  
charging time: 3.5 h  
curing area: Ø 20 cm  
**operating time 1.5 h**  
IP 67  
↓ 7 x 17 x 16 cm / 0.9 kg  
⊗ 7 x 17 x 18 cm / 1 kg  
061620

Curing area  
Ø 20 cm

SCANGRIP®



**ANTI-STATIC IONIZER GUN** - Pistolet anti-statique Ionizer Pro - Antistatische Ionisatorpistole

087866

**Laser pointer 650 nm**  
 < 1 mW class II

**Battery**  
 LIPO 1800 mAh - 3.7 V

Output voltage : 6500 V

**NEW**

- ✓ Neutralizes static electricity
- Neutralise l'électricité statique
- Neutralisiert statische Elektrizität

**Ex** ATEX norm  
 Group II - Category 3

**Charger**  
 Input : 110/230V ~50/60Hz  
 Output : 5 V DC

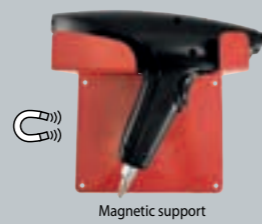

**FILM COATING THICKNESS GAUGE**  
 - Détecteur épaisseur de peinture

059856

Measurement range : 0 - 1.80mm  
 Resolution : 0.01mm / 1mm  
 Measurement error : +/- 0.03 mm  
 Power Supply : 2x 1.5V AAA batteries (included)  
 Overall dimensions : 62 x 30.5 x 105 mm

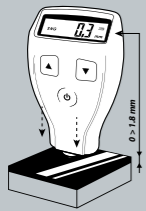

**4 MAGNETIC PANEL EDGE PROTECTIONS**  
 - 4 protections magnétiques de ponçage pour bord de panneau

082793

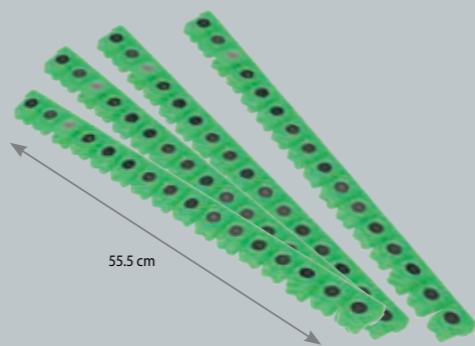

55.5 cm



**ELECTRIC SANDER & POLISHER** - Ponçeuse /polisseuse électrique - Elektro-Polier-Schleifer

057999

Orbital 5.0 mm  
 ↓ 27 x 15 x 10 cm / 1.5 kg  
 ⌀ 37 x 18 x 12 cm / 1.9 kg

Speed : 4000, 7000, 9000 10000 rpm  
 AC-in 220V - 230V / 50 - 60Hz

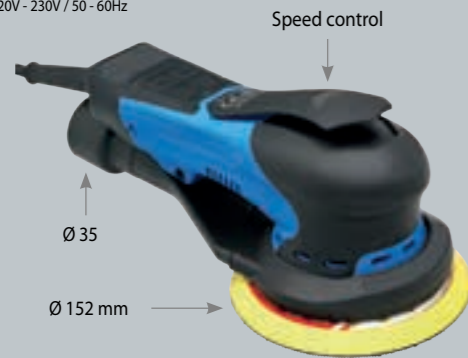

Speed control

Ø 35

Ø 152 mm

Light weight  
 & Compact

(( No vibration ))



058293

Power supply : 230V / 50Hz  
 Power : 1400W (max 2000W)  
 Max. vacuum : 170 mbar  
 Air flow : 2700 l/min  
 Drum capacity : 30 L  
 Drum material : stainless steel

↓ 33 x 33 x 63 cm / 4.9 kg  
 ⌀ 38 x 38 x 67 cm / 7.8 kg

Manual  
 OR  
 automatic



4m  
 Input Ø 32 mm  
 Mains cable length 4.5m

**GYSDUST EXTRACTOR** - Pneumatic dust vacuum cleaner for sander

**INNOVATIVE SUCTION SYSTEM**

Depression 1150 mm H2O  
 Air flow 600 l/min  
 Air consumption 340 l/min

**PATENT PENDING**  
 BREVET GYS  
 GYS PATENT



Adjustable sander pressure - Pression ponçeuse ajustable  
**5 bar max**

↓ 49 x 48 x 88 cm / 21.5 kg  
 ⌀ 81 x 40 x 49 cm / 24.1 kg

**Ex** ATEX norm  
 Group II - Category 3

EN 60335-2-69 : 2012

- ✓ ROBUST
- ✓ QUICK & SAFE
- ✓ LOW AIR CONSUMPTION (5 bar)
- ✓ NO ELECTRIC MOTOR
- ✓ ENERGY SAVING

Sanding discs box\*  
 - Rangement pour disques de ponçage\*  
 \* discs box not included - disques de ponçage non inclus



**Grande maniabilité et stabilité**  
 - High maneuverability and stability

**EASY ACCESS**

Maintenance free  
 - Aucune maintenance



**Consumables**

Sac à poussières - Filter bag  
 Capacity 5 kg  
**Included x1**  
 x 5  
 058880

**Options**

Pneumatic Sander - Ponçeuse pneumatique  
**MIRKA PROS 650CV**  
 Ø 150 mm  
 071346



5 mm

**NEW** 04/2025  
 Pneumatic Sander - Ponçeuse pneumatique  
 Made in China  
 Ø 150 mm  
 087897



5 mm

**2 MODELS**

**GYSDUST EXTRACTOR**

**MANUAL**

Manual start  
 - Démarrage manuel

071353



**GYSDUST SELF EXTRACTOR**

**AUTOMATIC**

Automatic start  
 - Démarrage automatique

077058



**ERGONOMIC PRO SUPPORT FOR PAINTING ELEMENTS** - Support Pro ergonomique pour peinture d'éléments  
- Ergonomische Pro-Unterstützung für Malelemente

082656

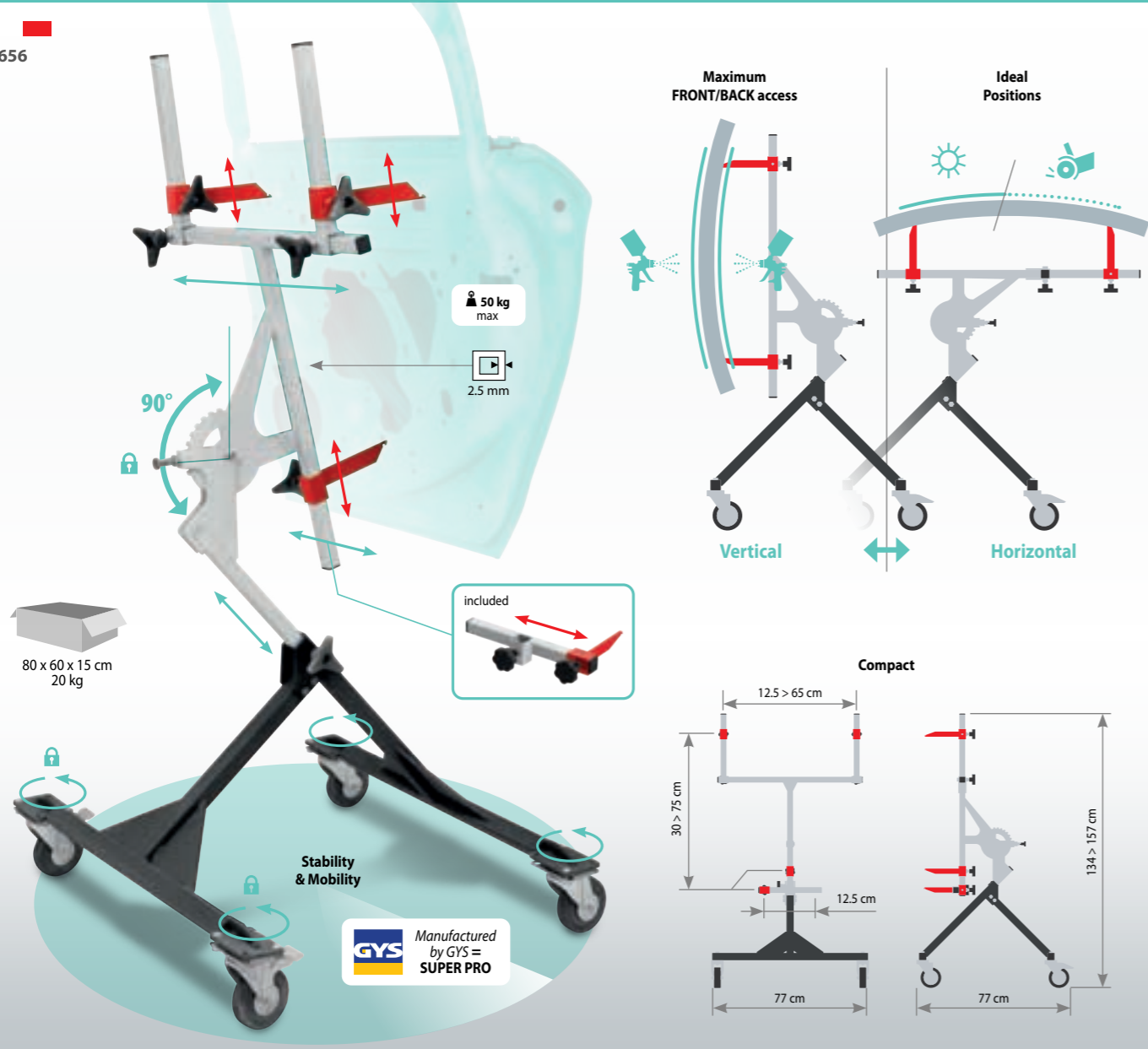

**ROTARY ELEMENT SUPPORT** - Support élément rotatif  
- Lackierständer für Stoßstange, einstellbar

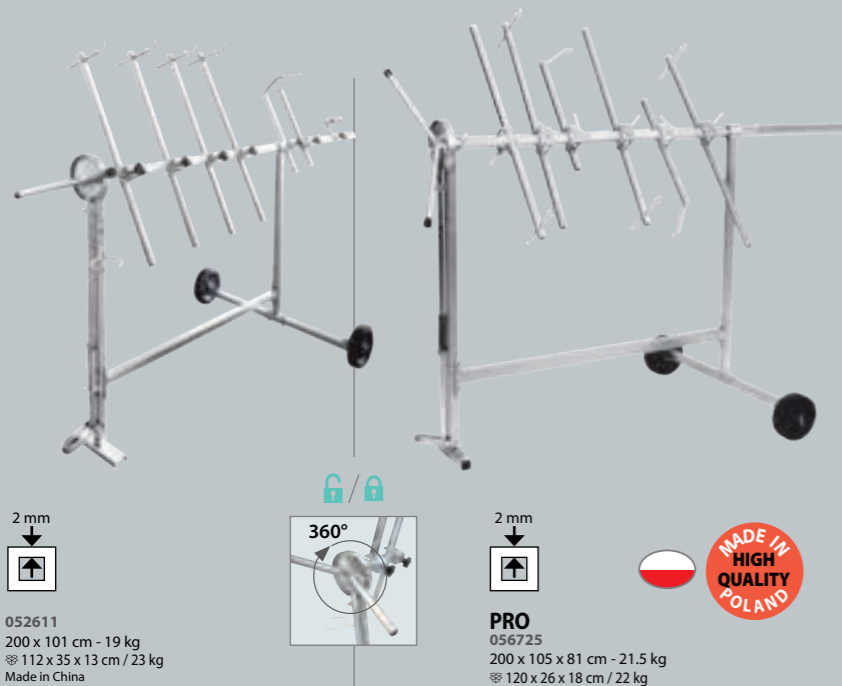

**WHEELS PAINTING SUPPORT** - Support de peinture pour 2 jantes - Lackträger für 2 Felgen

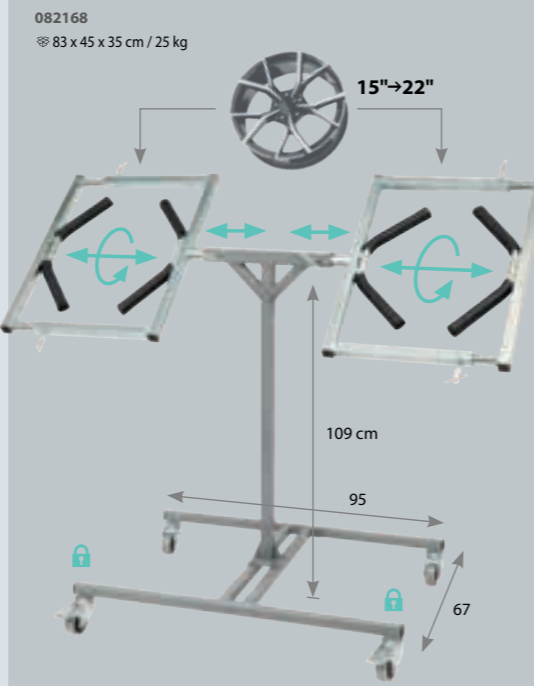

**FRAMES SUPPORT** - Tréteaux - Klappbücke

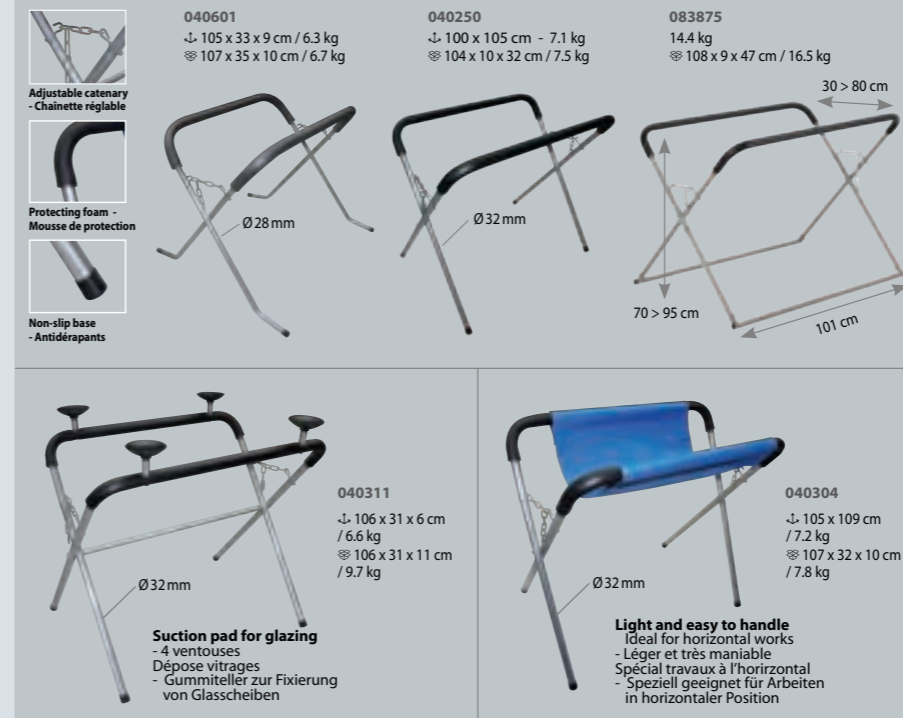

**ROTARY ELEMENT SUPPORT**  
- Support pare-chocs - Lackierständer für Stoßstange, einstellbar



**TELESCOPIC FRAMES SUPPORT** - Tréteaux télescopiques - Teleskopbücke

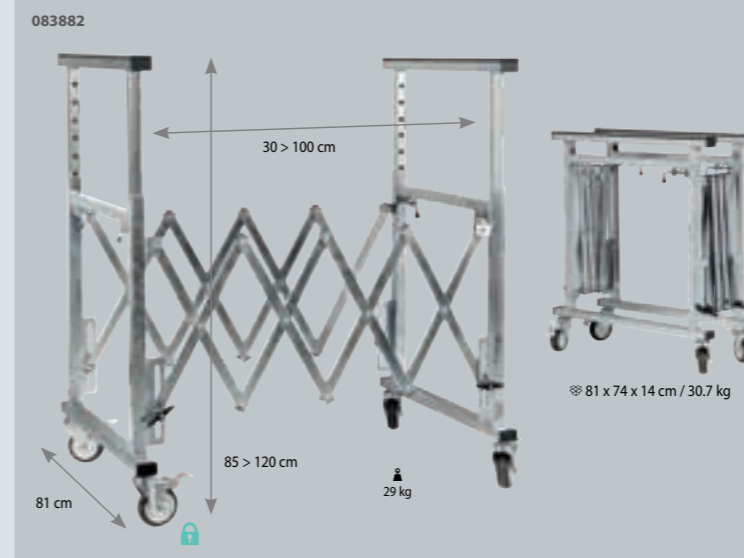

**SUSPENSION RACK FOR CAR BODY PANELS**  
- Portant pour suspension d'éléments de carrosserie

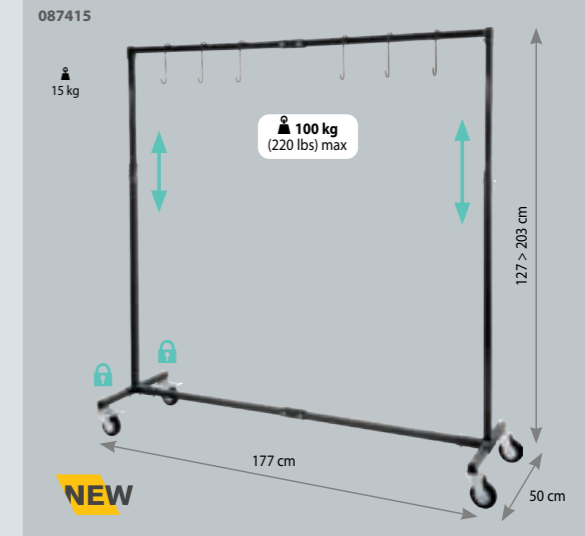

**MASKING MACHINE**  
- Chariot de marouflage - Abdeckpapier-Ständer



**MASKING MACHINE**  
- Diable de marouflage - Abdeckpapier-Ständer



**MOBILE RACKS FOR CAR BODY REPAIR** - Racks mobiles pour éléments de carrosserie - Mobile Regale für Karosserieteile

082472  
⊗ 128 x 30 x 15 cm / 20 kg  
↓ 18.8 kg

**NEW**

63.5 cm  
120 cm  
70 cm

150 kg max

083899  
3.9 kg  
⊗ 61 x 36 x 16 cm / 4.6 kg

**NEW**

52 cm  
63.5 cm  
78 cm  
44 cm  
9 cm  
152 cm  
58 cm

15 positions  
8 separators

**ROUND STOOL WITH TOOL STORAGE**  
- Tabouret - Werkstatt-Rollhocker

057555  
38 x 38 x 44 cm - 5.2 kg  
⊗ 41 x 19 x 41 cm / 5.6 kg

max: 50 cm  
min: 38 cm  
6 cm

**PLASTIC STOOL WITH TOOL STORAGE**  
- Tabouret en plastique avec rangements - Kunststoffhocker

085916  
3.9 kg  
⊗ 61 x 36 x 16 cm / 4.6 kg

**NEW**

46 cm  
34 cm  
44 cm  
39 cm  
37 cm  
59 cm

**STORAGE TROLLEYS** - Chariots de stockage - Lagerrollwagen

040243

71 x 90 x 197 cm / 41 kg

⊗ x2:  
90 x 6 x 147 cm  
+ 97 x 74 x 24 cm

059825

50 cm

106 x 104 x 215 cm - 32.5 kg  
112 x 31.5 x 21.5 cm  
+ 12 x 9.5 x 194.5 cm

**WALL STORAGE** - Stockage mural - Wandspeicher

059832

50 cm

↓ 50 x 150 cm / 11.3 kg  
⊗ 155 x 18 x 12 cm / 13.8 kg

**3-DRAWER WORKSHOP STOOL** - Tabouret d'atelier 3 tiroirs - Werkstatthocker 3 Schubladen

079878  
47 x 35 x 43 cm / 12 kg  
⊗ 38.5 x 37 x 38.5 cm / 13 kg

150 kg max

**FOLDING STEP STOOLS** - Marche pieds (Aluminium) - Arbeitspodest klappbar

080041  
7.3 kg  
⊗ 100 x 39.5 x 19 cm / 8.1 kg

**ALU**

150 kg max

850 mm  
490 mm  
1180 mm  
300 mm

**MECHANICS CREEPER WITH TILTING HEADREST** - Chariot de visite - Werkstatt-Rollliege

057548  
102 x 43 x 11 cm / 5.3 kg  
⊗ 104 x 45 x 13 cm / 6 kg

136 kg (300 lbs) max

057562  
7.9 kg  
⊗ 102 x 39 x 19 cm / 8.5 kg

**ALU**

150 kg max

960 mm  
475 mm  
385 mm

**UNIVERSAL SUPPORT** - Chariot pour éléments de carrosserie - Universelle Ständer

083868  
56 kg  
⊗ 102 x 72 x 27 cm / 59 kg

**NEW**

210 cm  
+60 cm  
85 cm  
100 cm

**FLAP LOCKS** - Jeux de tiges de blocage

056732

30 > 115 cm

**MADE IN HIGH QUALITY POLAND**

087903

**NEW**

30 > 126 cm

**2 IN 1 MECHANICS CREEPER** - Chariot de visite 2 en 1 - Werkstatt-Rollliege

079861  
102 x 40 x 14 cm  
⊗ 40 x 13 x 63 cm - 7.6 kg

136 kg (300 lbs) max

058552  
↓ 113 x 41 x 16 cm / 16 kg  
⊗ 117 x 42 x 17 cm / 17 kg

**ALU**

150 kg max

1090 > 1750 mm  
520 > 900 mm  
300 mm

**WORKSTATION PREMIUM 5 DRAWERS**  
- Servante premium 5 tiroirs



076143  
 ⚖ 64 kg  
**Capacity 320 kg**

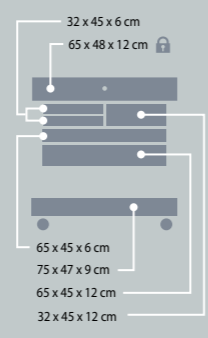

Example of use  
- Exemple d'utilisation (p. 51)

**PLASTIC TROLLEY 3 SHELVES** - Servante plastique 3 plateaux



**NEW**

**WORKSTATION 3 SHELVES 1 DRAWER**  
- Servante d'atelier 3 plateaux 1 tiroir



**NEW**  
04/2025

**MOBILE WORKSTATION**  
- Table de travail mobile



**100 kg max**

**WORKSTATION 3 SHELVES**  
- Servante 3 plateaux



**65 kg max**

**65 kg max**

**65 kg max**

**HEAT COVER** - Couverture anti-chaueur - Hitzeschutzdecke - Manta anti-calor - Protecção anti-aquecimento



PROTEC 550  
550°C/1000°F - Class M0  
2 m x 2 m - 580 g/m²  
050495

PROTEC 1200  
1200°C/2200°F - Class M0  
1.75 m x 1.5 m - 1200 g/m²  
050204

PROTEC 1300  
1300°C/2400°F - Class M0  
XL: 2 m x 1.8 m - 620 g/m²  
053595

PROTEC 1300L  
1300°C/2400°F  
XL: 2 m x 1.8 m - 427 g/m²  
060500

**SET OF 2 MAGNETS**  
- Jeu de 2 aimants - Schweißmagnet

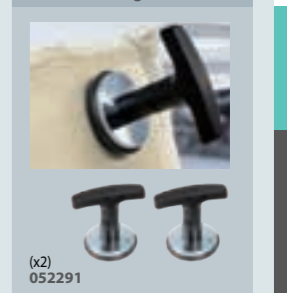

(x2)  
052291

**MAGNETIC COVER** - Couverture magnétique - Magnetschutzdecke

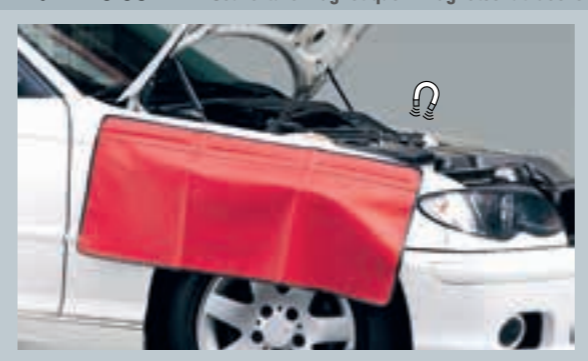

1.06 m x 0.6 m  
061446

**RIDEAU DE SOUDAGE** - Welding curtain and frame - Schweißerschutzwand

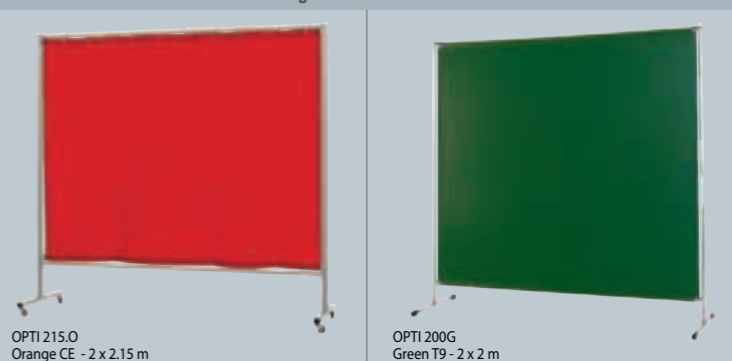

OPTI 215.O  
Orange CE - 2 x 2.15 m  
EN 25980 - 2015/01  
060470

OPTI 200G  
Green T9 - 2 x 2 m  
EN 25980 - 2015/01  
060463

**RESPIRATORY MASKS** - Masques respiratoires - Atemschutzmaske - Máscaras respiratorias



FFP3 - EN 140 / EN 143 / EN 166  
(x1) Size M/L  
037021

FFP3 - EN 140 / EN 143  
(x1) Size M/L  
037014

Étui / Case  
037045

FFP3 - EN 143 : 2000 P3  
Anti poussières / Anti odeurs  
037038

**PROTECTION GOGGLES**  
- Lunettes de protection - Schutzbrillen



EN 166

Shade/RO  
042810

Shade/RO  
042827

Shade/RS  
042841

Shade/RO  
047778

Shade/RO  
047792

Shade/RO  
042865

Shade/RO  
047839

**GLOVES** - Gants - Handschuhe - Guantes



Anti-cut  
anti-coupe  
T9  
045897

EN388  
4342

✓ touch screen  
friendly  
- écran tactile  
High resistance anti-cut  
Anti coupure  
haute résistance  
EN 420  
EN 388:4121  
T9: 045910  
T10: 045927

High dexterity  
anti-cut  
- Anti coupure  
haute dextérité  
EN 420  
EN 388:1121  
T9: 045903  
T10: 045934

T10  
064188

EN420  
2003

Ultra  
Flexible  
EN388  
2003

Heavy Duty T10  
(MMA - MIG - Plasma)  
045101

EN388  
4244

EN 407  
4231XX  
EN12477  
Class: A1

EN388  
2122

EN 407  
322X2X  
EN12477  
Class: A1

Reinforced welding gloves  
- Gants de soudage renforcés  
T10  
045873

EN388  
4244

EN 407  
424X4X  
EN12477  
Class: A1

EN388  
2011XX

EN 407  
41313X  
EN12477-B  
EN 420

**MULTI-USE LEATHER APRON**  
- Tablier cuir multi-usage  
- Delantal de cuero multi-uso  
- Mehrzweck-Lederschürze



PRO  
045217

**1T MOBILE LIFTING TABLE WITH HYDROPNEUMATIC PUMP** - Table élévatrice mobile 1 tonne avec pompe hydropneumatique  
- Mobilier 1-Tonnen-Hubtisch mit hydropneumatischer Pumpe

083912  
Weight : 385 kg

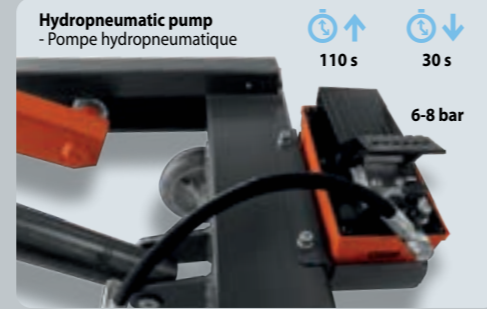
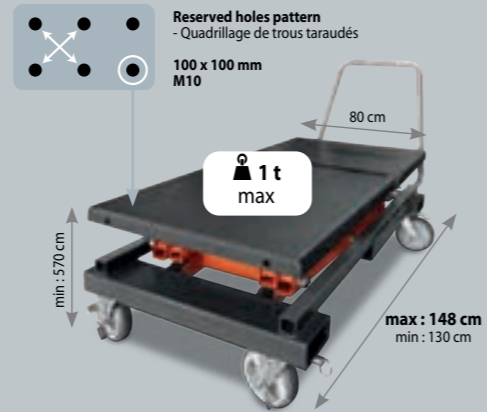

**1.2T LIFTING TABLE FOR ELECTRIC VEHICLE BATTERIES** - Table de levage 1.2T pour batteries de véhicule électrique  
- 1,2T Hubtisch für Elektrofahrzeugbatterien

Weight : 760 kg

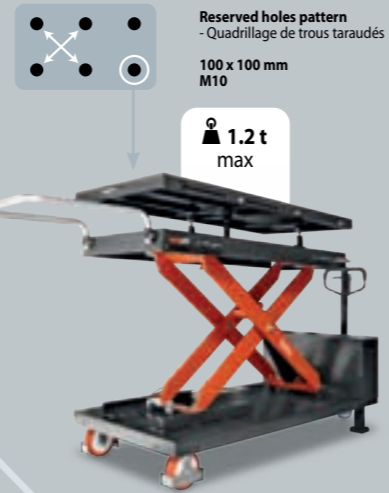
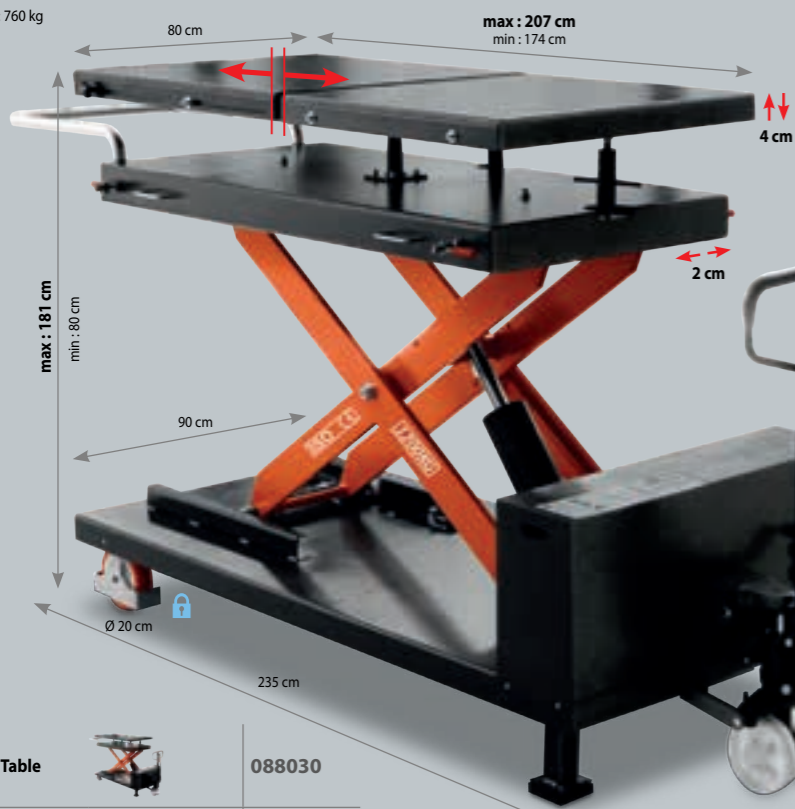

- Lifting Table 088030
- Lifting Table + 5L Hydraulic oil 083929

Lifting table pins  
- Piges pour table de levage  
- Stangen für Hubtisch  
085176

NEW



for  
1.2T  
Lifting Table



**EQUIPMENT FOR OPERATIONS ON ELECTRIC AND HYBRID VEHICLES** - Équipements pour opérations sur véhicules électriques & hybrides  
- Ausrüstung für den Betrieb von Elektro- und Hybridfahrzeugen

FACE SHIELD WITH HEADBAND  
- ÉCRAN FACIAL AVEC SERRE-TÊTE  
068018



INSULATING GLOVES (T10)  
- GANTS ISOLANTS (T10)  
068025



25 pieces insulated tools 1000V - Coffret de 25 outils isolés 1000V  
066489

- 7/8/10/12/14/15/17/19/22 mm sockets - Douilles 7/8/10/12/14/15/17/19/22 mm x 9
- 175 mm universal pliers in chrome vanadium - Pince universelle de 175 mm en chrome vanadium x 1
- Cutting pliers 150 mm in chrome vanadium - Pince coupante 150 mm en chrome vanadium x 1
- 3/8" ratchet - Cliquet en 3/8" x 1
- Extension 100 mm - Rallonge 100 mm x 1
- T-handle - Poignée en T x 1
- Open ended wrenches 7/8/10/12/14/17 mm - Clés plates à fourches 7/8/10/12/14/17 mm x 6
- Cable knife - Couteau pour câble x 1
- Phillips PhH1x100/PhH2x100 mm screwdriver - Tournevis Phillips PhH1x100/PhH2x100 mm x 2
- Flat screwdriver 5.5x125/4x100 mm - Tournevis plats 5.5x125/4x100 mm x 2



Kit for marking the area of intervention  
- Kit pour le balisage de la zone d'intervention  
- Kennzeichnungsset für Hochvolt-Bereiche  
064409

- Red and white warning pole - Balise de signalisation rouge et blanche x 4
- Red and white bounding line - Chaîne de délimitation rouge et blanche x 1
- Sign board "Danger, working area EHV" - Pancarte de signalisation "Danger, zone de travail VEH" x 2



COMING SOON  
083837

TROUSERS  
- Pantalon - Hose

- 98% cotton, 2% antistatic
- S (40/42) 046368
- M (44/46) 046375
- L (48/50) 046382
- XL (52/54) 046399
- XXL (56/58) 046412
- EN ISO 11611 Class 2-A1 & A2
- EN ISO 11612 A1+A2-B1-C1-E3-F1
- EN 1149-5
- IEC 61482-2 Class 1-4KA
- EN 14404 +A1 Type 2

JACKET  
- Veste - Jacke

- 98% cotton, 2% antistatic
- S (40/42) 046313
- M (44/46) 046320
- L (48/50) 046337
- XL (52/54) 046344
- XXL (56/58) 046351
- EN ISO 11611 Class 2-A1 & A2
- EN 1149-5
- EN ISO 11612 A1+A2-B1-C1-E3-F1
- EN 14404 +A1 Type 2
- IEC 61482-2 Class 1-4KA

MARKETING

143

ELECTRIC CARS  
MARKETING

Display stand  
- Podium de présentation  
- Podest

- PODIUM 2  
A: 80 cm  
B: 50 cm  
C: 50 cm  
063211
- PODIUM 1  
A: 45 cm  
B: 50 cm  
C: 50 cm  
063204

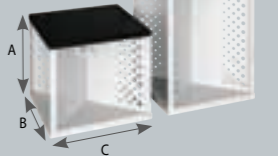

Retail display space with 2 shelves  
- Linéaire de vente avec 2 étagères  
- Lochwandregal mit 2 Böden  
060784



Banner  
- Oriflamme  
3 x 0,50 m  
098015



Barnum 3 x 3 m  
098022



Open barnum  
2 x 2 m  
098039





INVEST IN THE FUTURE

# COLLISION REPAIR

2025 A

## GYS France

### Headquarters

1 rue de la Croix des Landes  
CS 54159  
53941 Saint-Berthevin - Cedex  
Laval - France  
Tel +33 2 43 01 23 60  
E-mail [service.client@gys.fr](mailto:service.client@gys.fr)



ZI, 134 bd des Loges  
53941 Saint-Berthevin  
Laval - France

### Logistic center

2 Rue Jean Dausset  
53810 Changé - France  
Tel +33 2 43 01 54 33

## GYS Germany

Professor-Wieler  
Straße 11  
52070 Aachen  
Deutschland  
Tel +49 241/189-23-710  
Fax +49 241/189-23-719  
E-mail [aachen@gys.fr](mailto:aachen@gys.fr)

## GYS UK

Unit 3 - Great Central Way  
Rugby - Warwickshire  
CV21 3XH  
United Kingdom  
Tel +44 1926 338 609  
Fax +44 1926 429 764  
E-mail [uk@gys.fr](mailto:uk@gys.fr)

## GYS Italia





Via Porta Est, 7  
30020 Marcon - VE  
Italia  
Tel +39 041 53 21 565  
E-mail [italia@gys.fr](mailto:italia@gys.fr)

## GYS Ibérica

Avenida Pirineos 31  
Nave 9  
San Sebastian de los Reyes  
28703 Madrid  
España  
Tel +34 917 409 790  
E-mail [iberica@gys.fr](mailto:iberica@gys.fr)

## GYS China

Lot N°15 - 6666 bd Songze  
201706 Qingpu  
Shanghai - China  
Tel +86 6221 4461  
Fax +86 5226 0067  
[www.gys-china.com.cn](http://www.gys-china.com.cn)  
E-mail  
[contact@gys-china.com.cn](mailto:contact@gys-china.com.cn)

 LinkedIn  
 YouTube  
 WeChat  
 Facebook  
 Instagram



[www.gys.fr](http://www.gys.fr)

Distributed by

